



OUTILS



RÈGLE, ÉQUERRE, RAPPORTEUR



SIXIÈME



TRIPLE DÉCIMÈTRES π

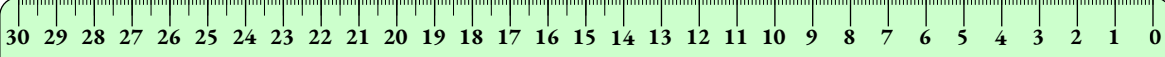

TRIPLE DÉCIMÈTRES π



TRIPLE DÉCIMÈTRES

SYMÉTRIE

π



DOUBLE DÉCIMÈTRES π



DOUBLE DÉCIMÈTRES π



DOUBLE DÉCIMÈTRES

SYMÉTRIE

π

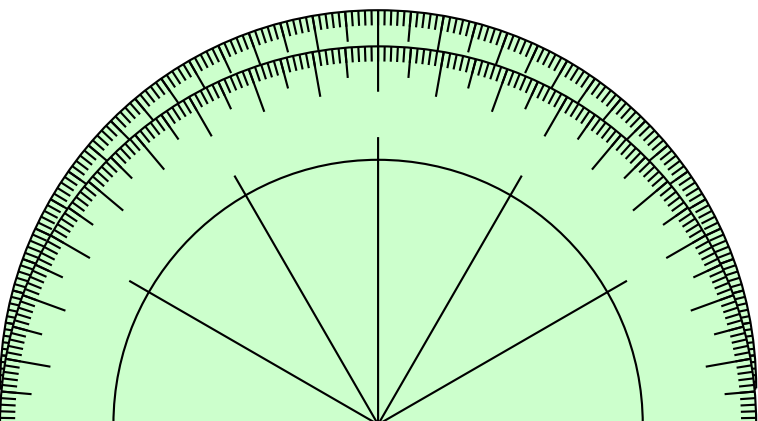
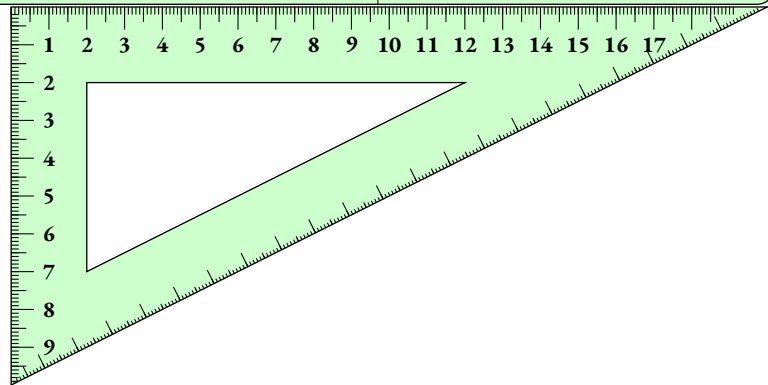

TRIPLE DÉCIMÈTRES

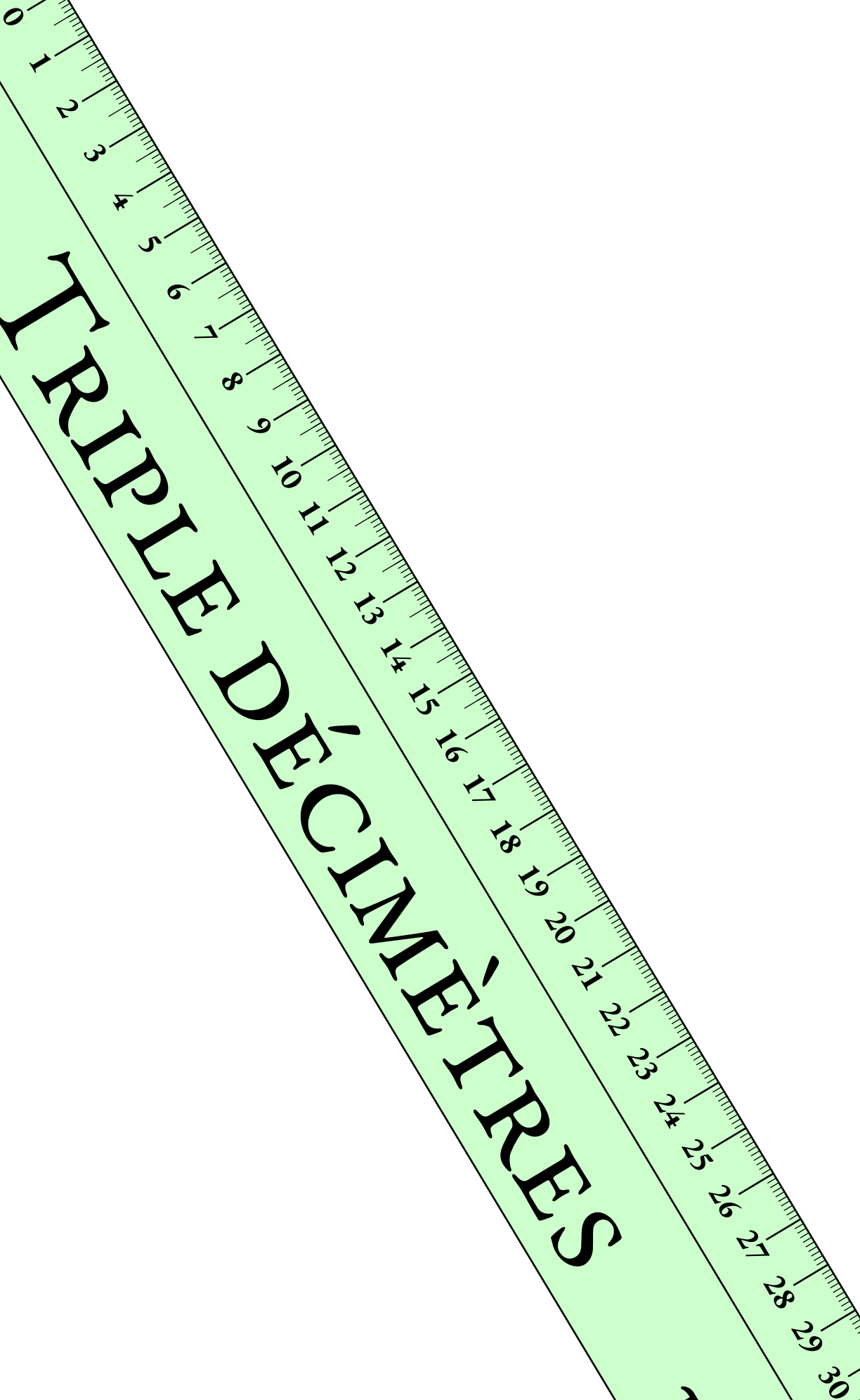

π

TRIPLE DÉCIMÈTRES

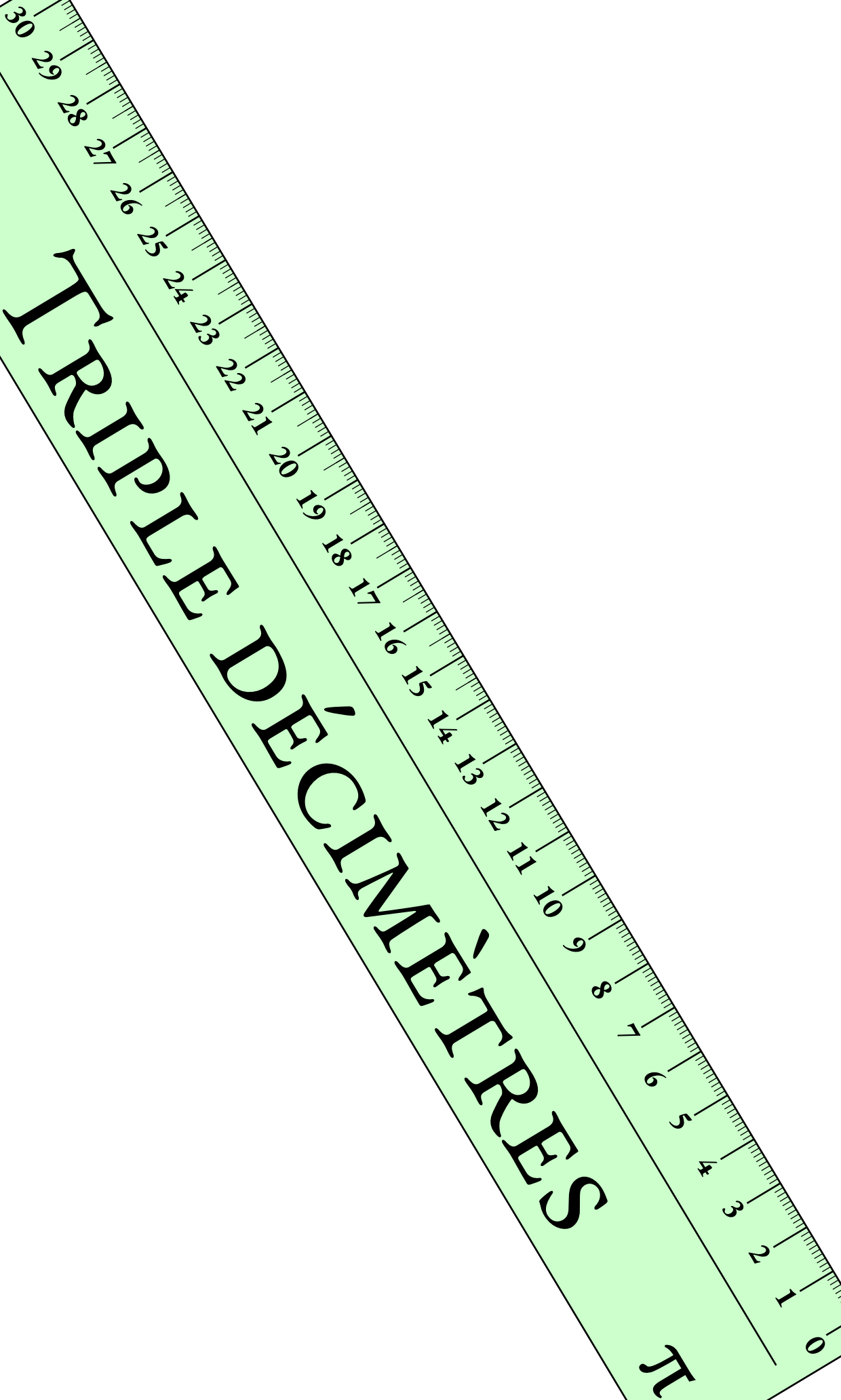

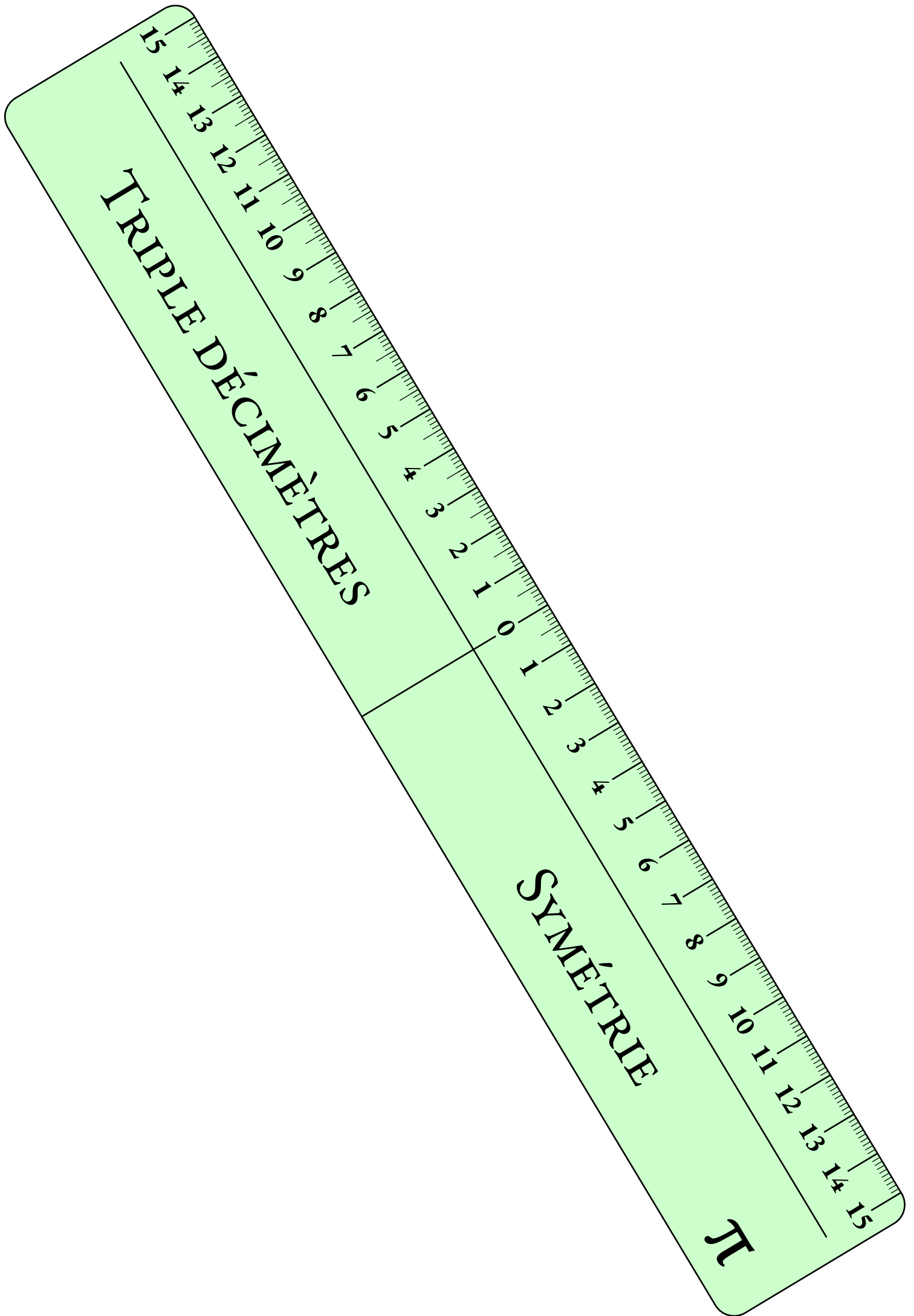

TRIPLE DÉCIMÈTRES

SYMÉTRIE

π

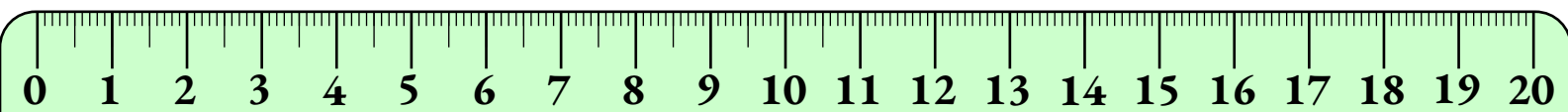

DOUBLE DÉCIMÈTRES π

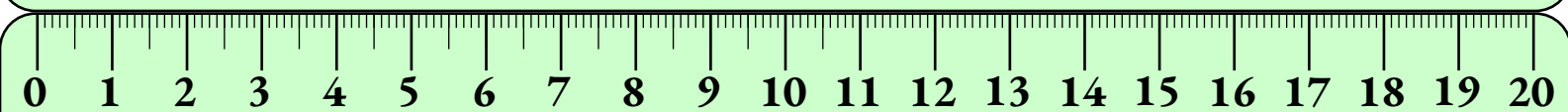

DOUBLE DÉCIMÈTRES π

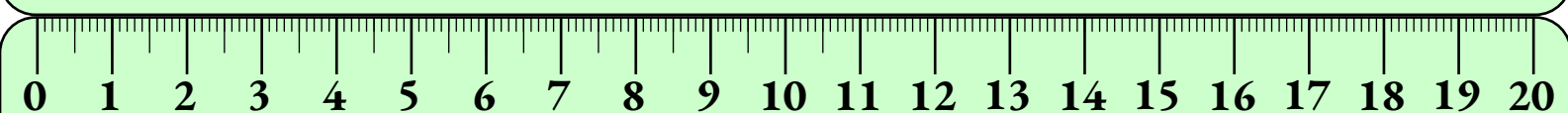

DOUBLE DÉCIMÈTRES π

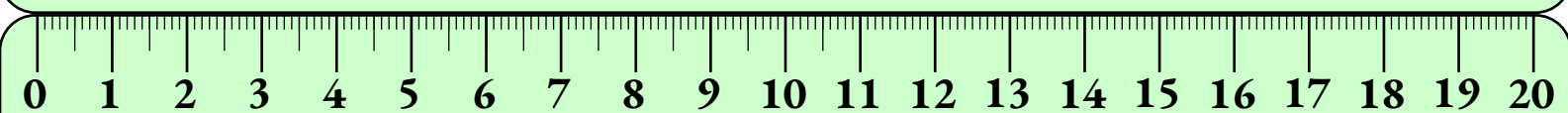

DOUBLE DÉCIMÈTRES π

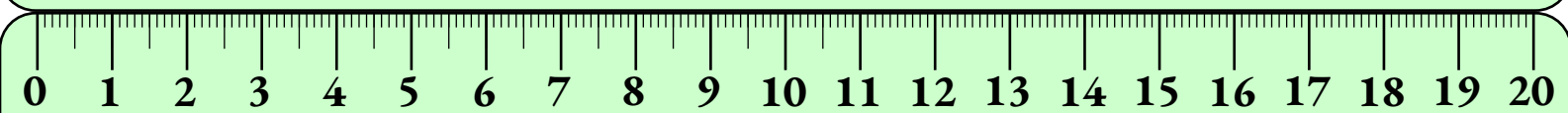

DOUBLE DÉCIMÈTRES π

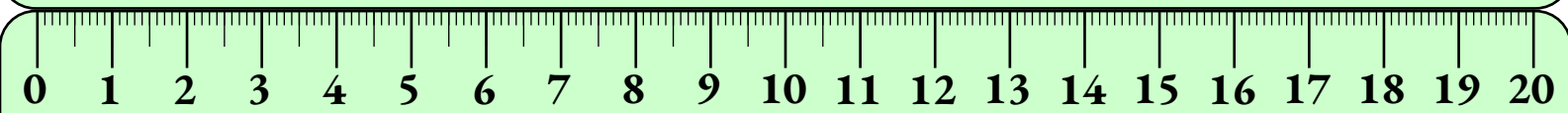

DOUBLE DÉCIMÈTRES π

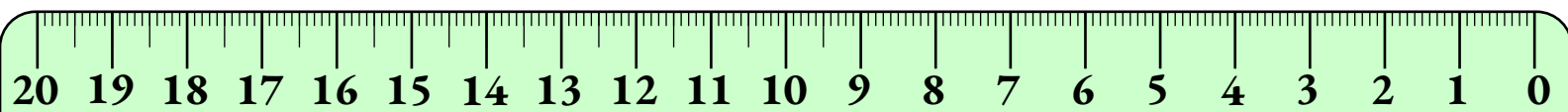

DOUBLE DÉCIMÈTRES π

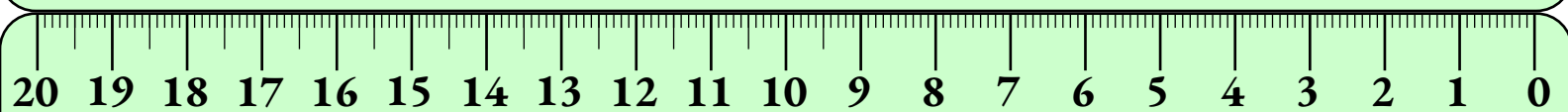

DOUBLE DÉCIMÈTRES π

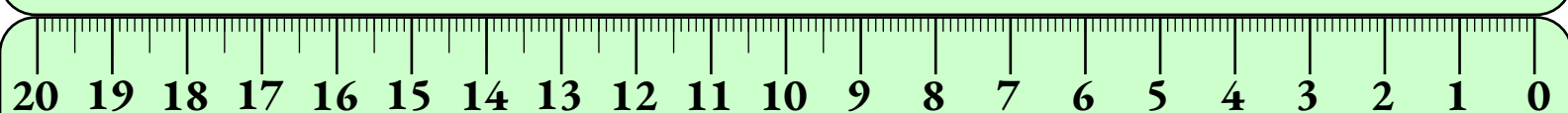

DOUBLE DÉCIMÈTRES π

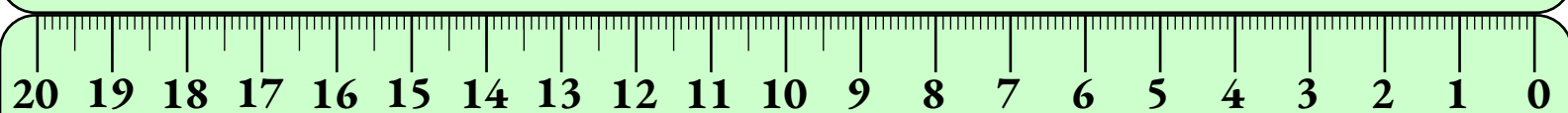

DOUBLE DÉCIMÈTRES π

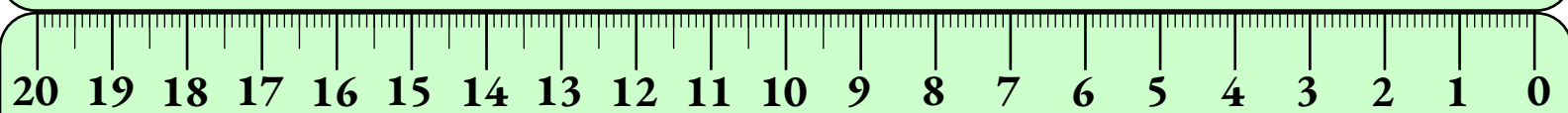

DOUBLE DÉCIMÈTRES π

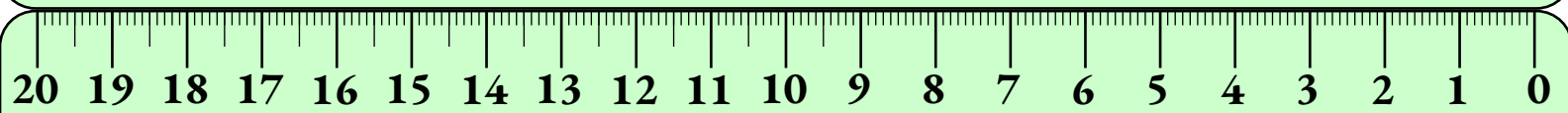

DOUBLE DÉCIMÈTRES π



DOUBLE DÉCIMÈTRES SYMÉTRIE π



DOUBLE DÉCIMÈTRES SYMÉTRIE π



DOUBLE DÉCIMÈTRES SYMÉTRIE π

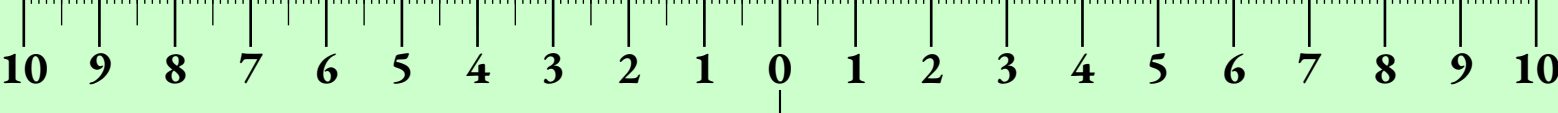

DOUBLE DÉCIMÈTRES SYMÉTRIE π



DOUBLE DÉCIMÈTRES SYMÉTRIE π

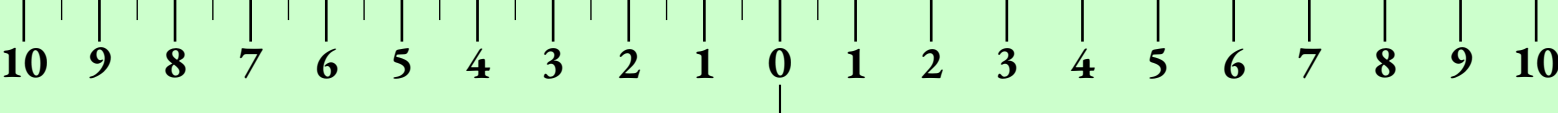

DOUBLE DÉCIMÈTRES SYMÉTRIE π

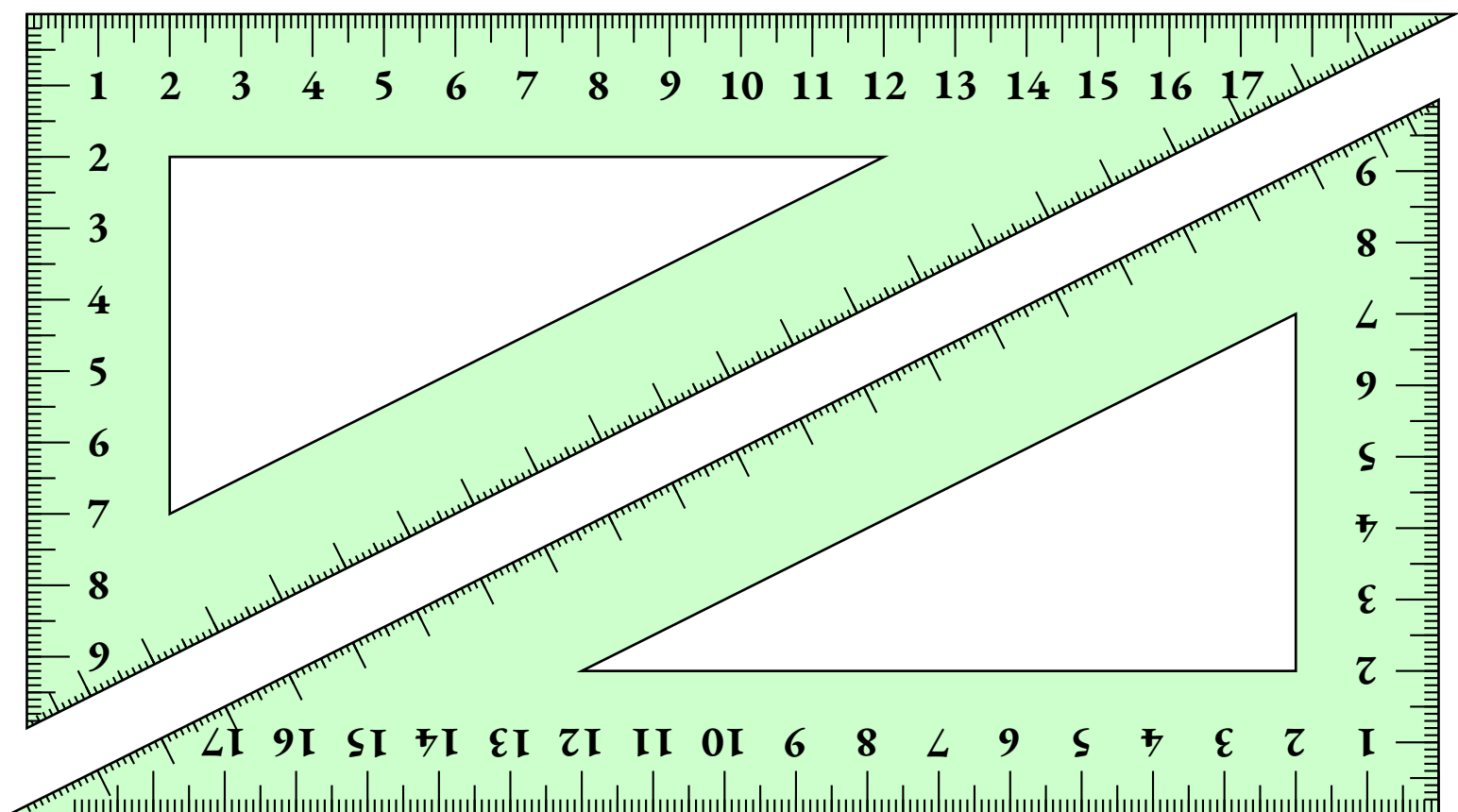
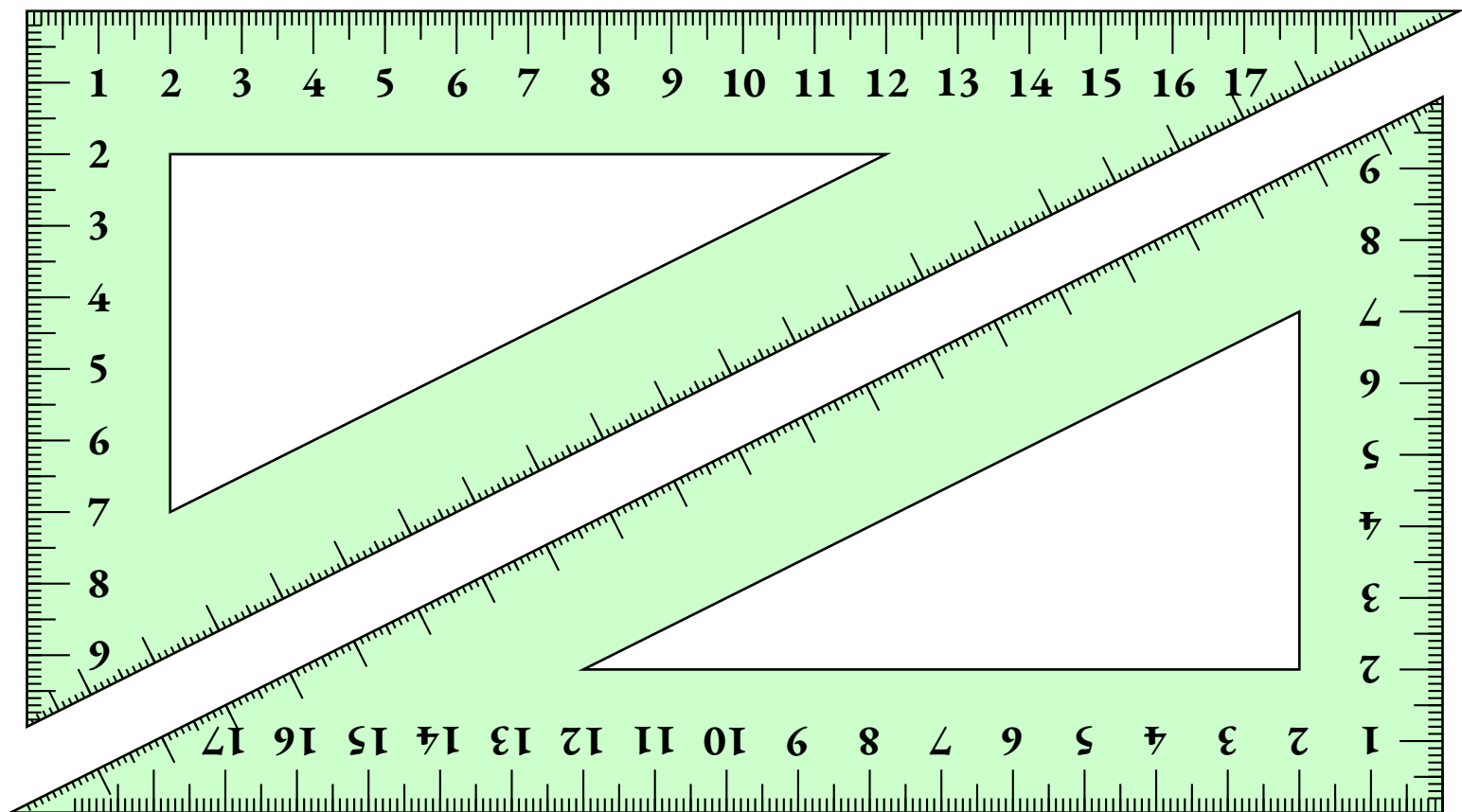

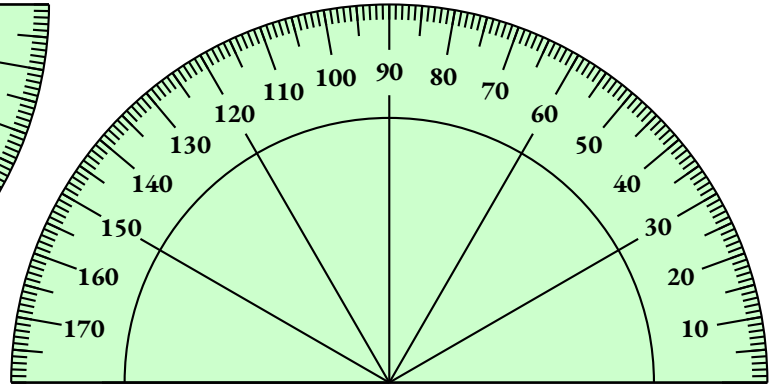
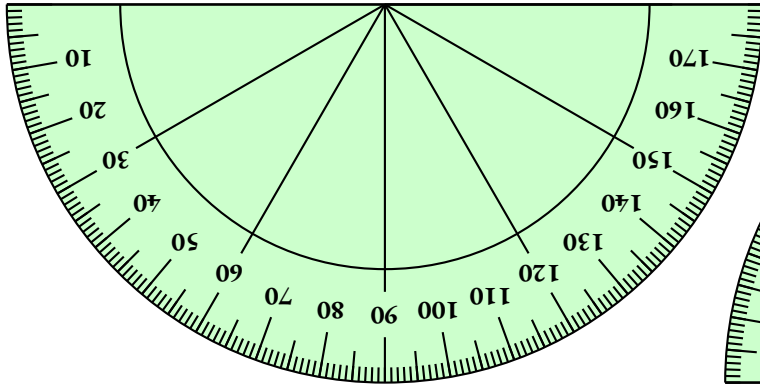
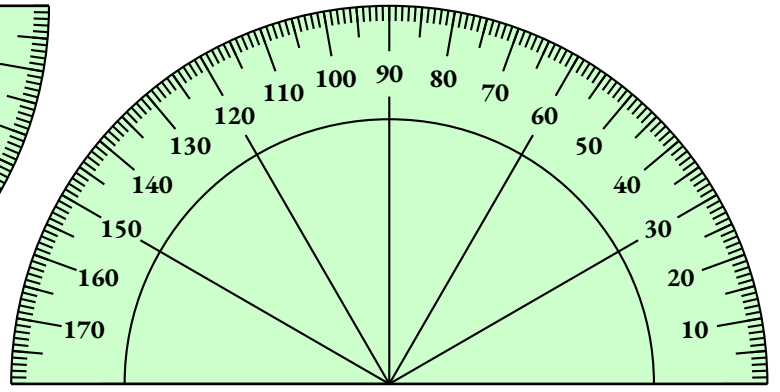
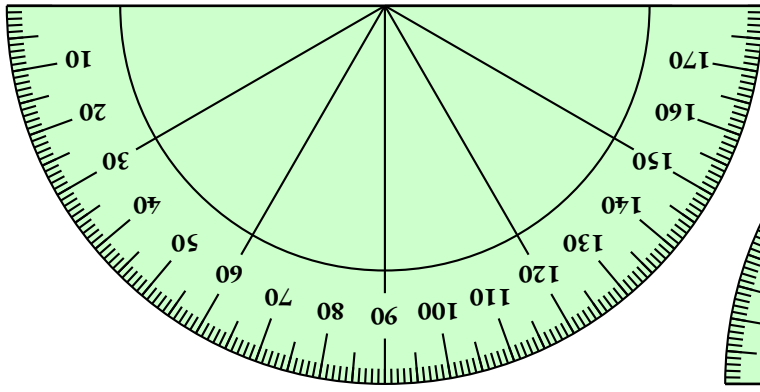
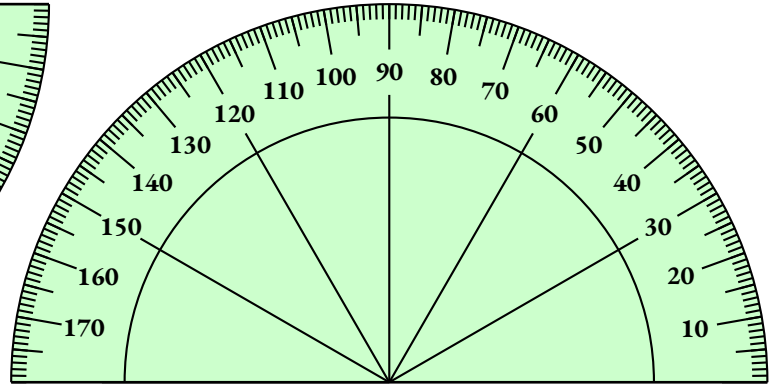
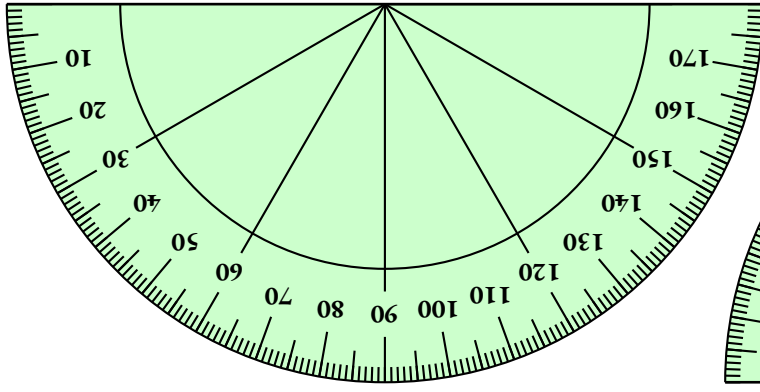
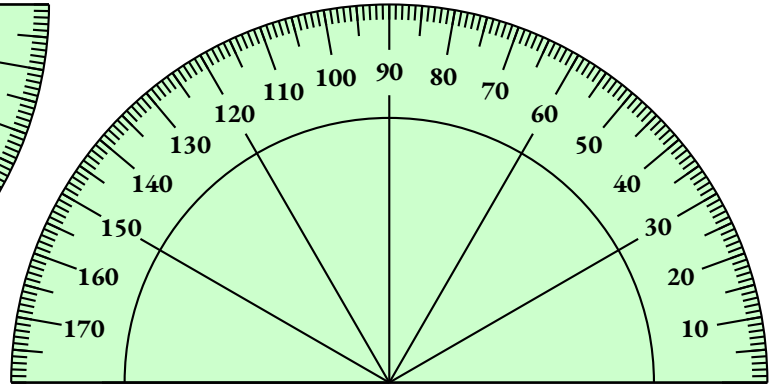
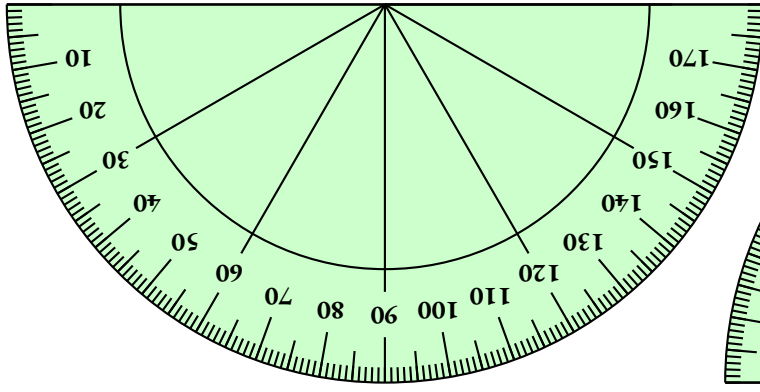
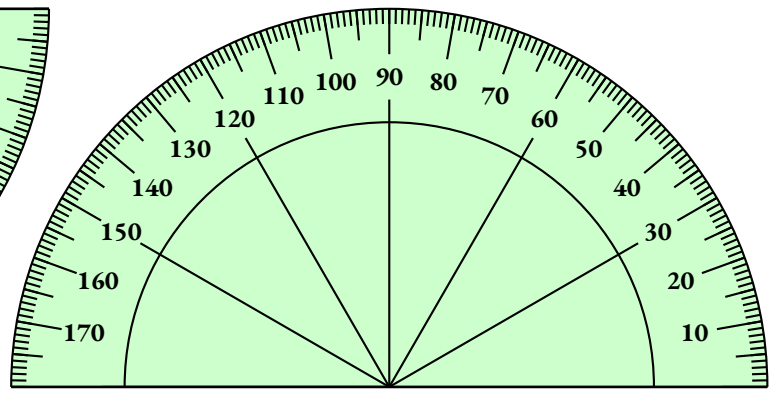
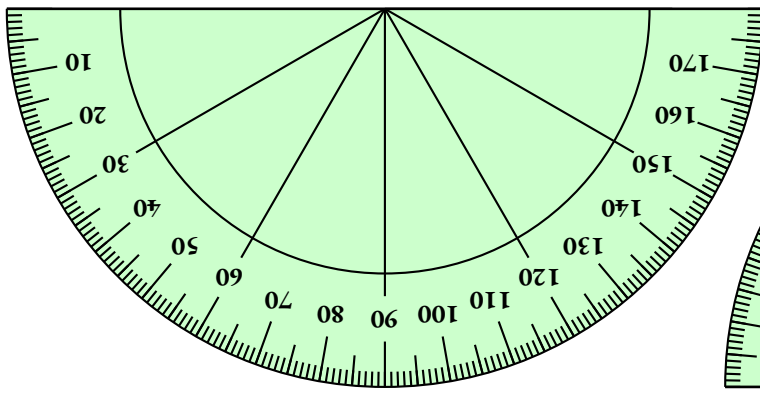

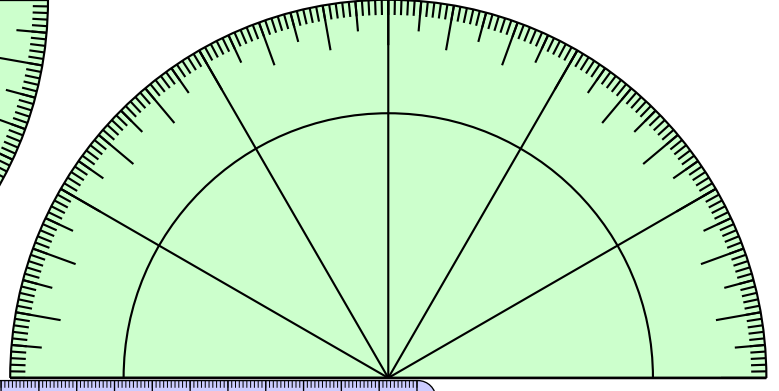
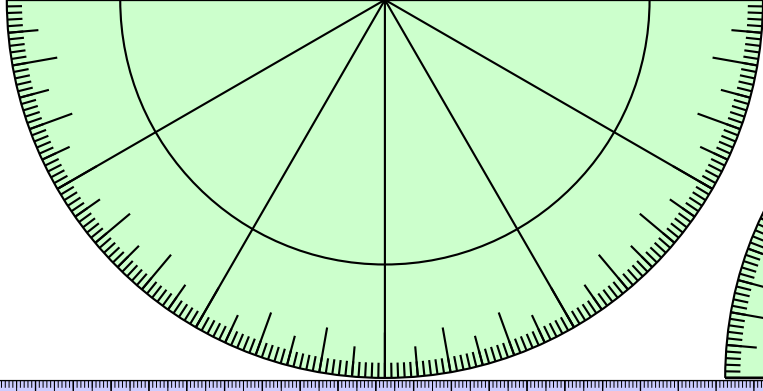
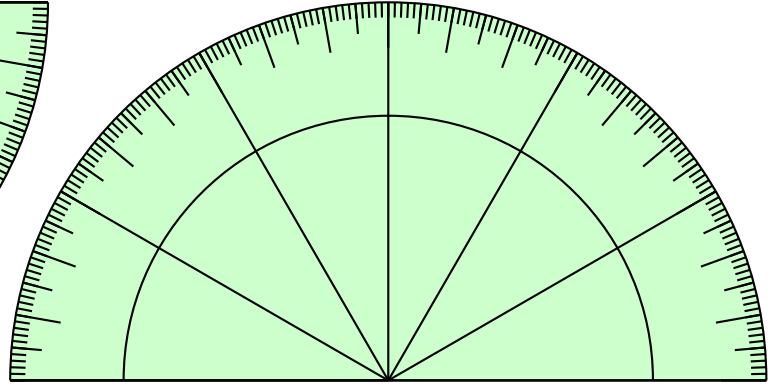
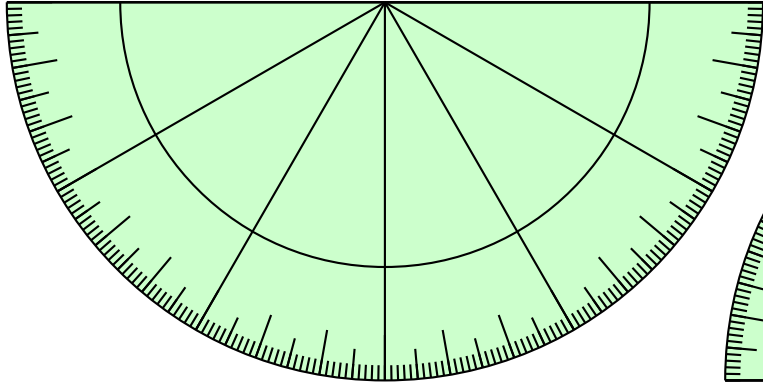
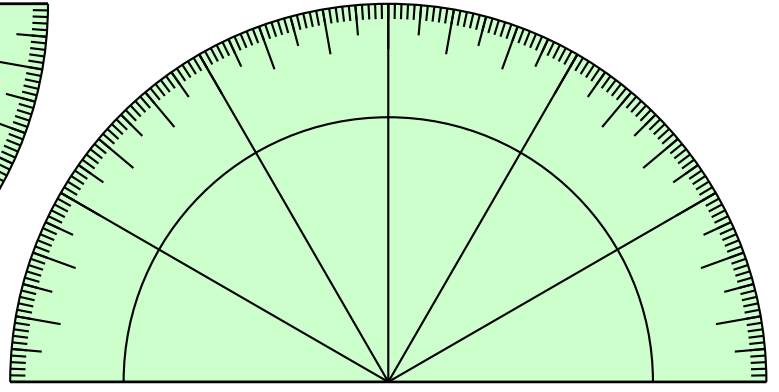
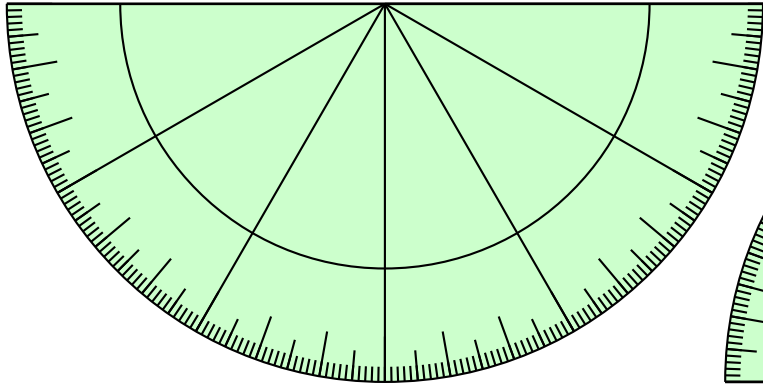
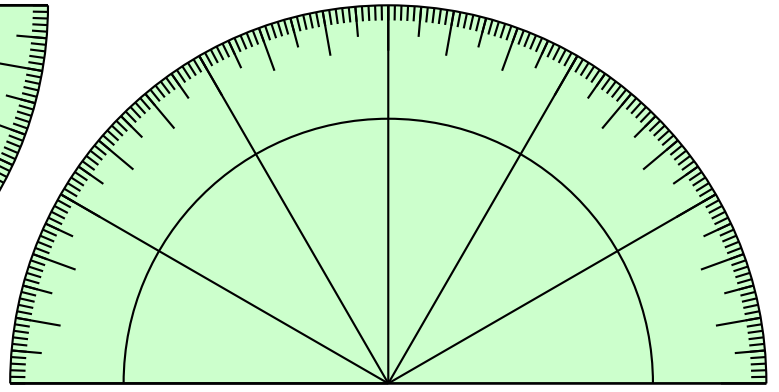
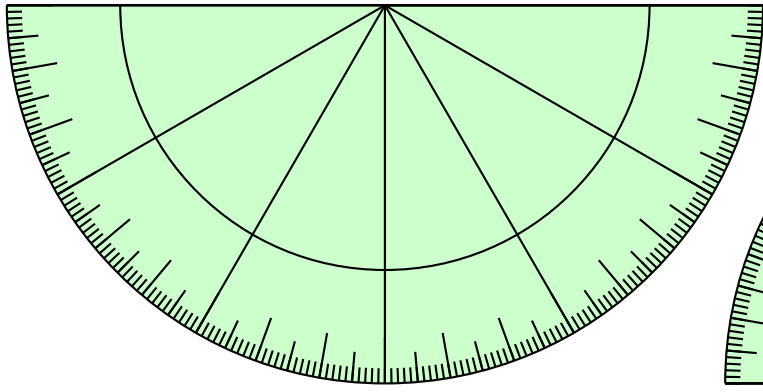
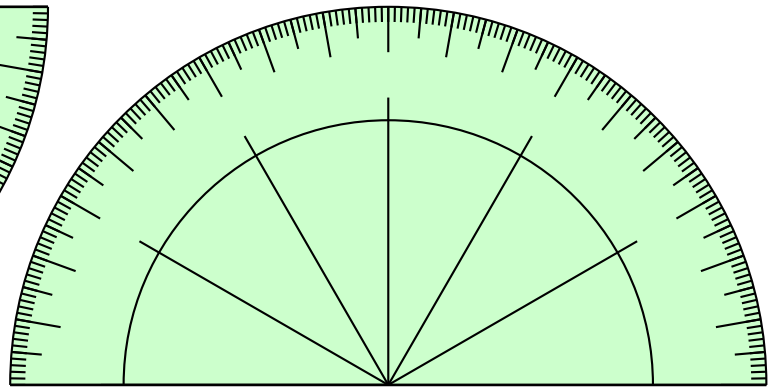
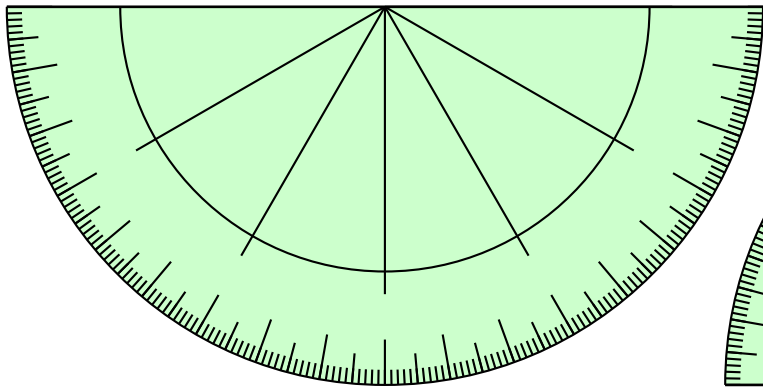

TRIPLE DÉCIMÈTRES

π



TRIPLE DÉCIMÈTRES π



TRIPLE DÉCIMÈTRES

SYMÉTRIE

π



DOUBLE DÉCIMÈTRES π



DOUBLE DÉCIMÈTRES π

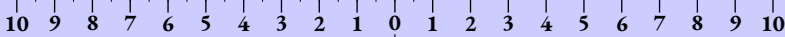

DOUBLE DÉCIMÈTRES

SYMÉTRIE

π

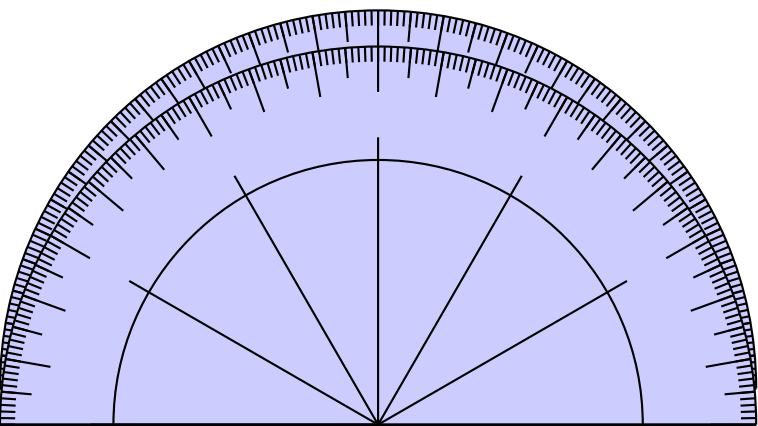
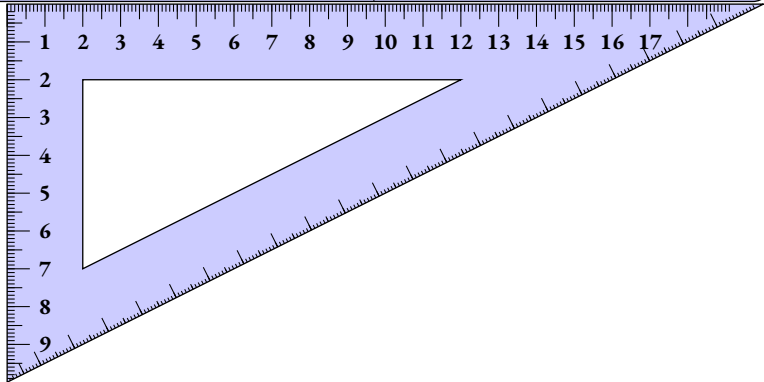

TRIPLE DÉCIMÈTRES

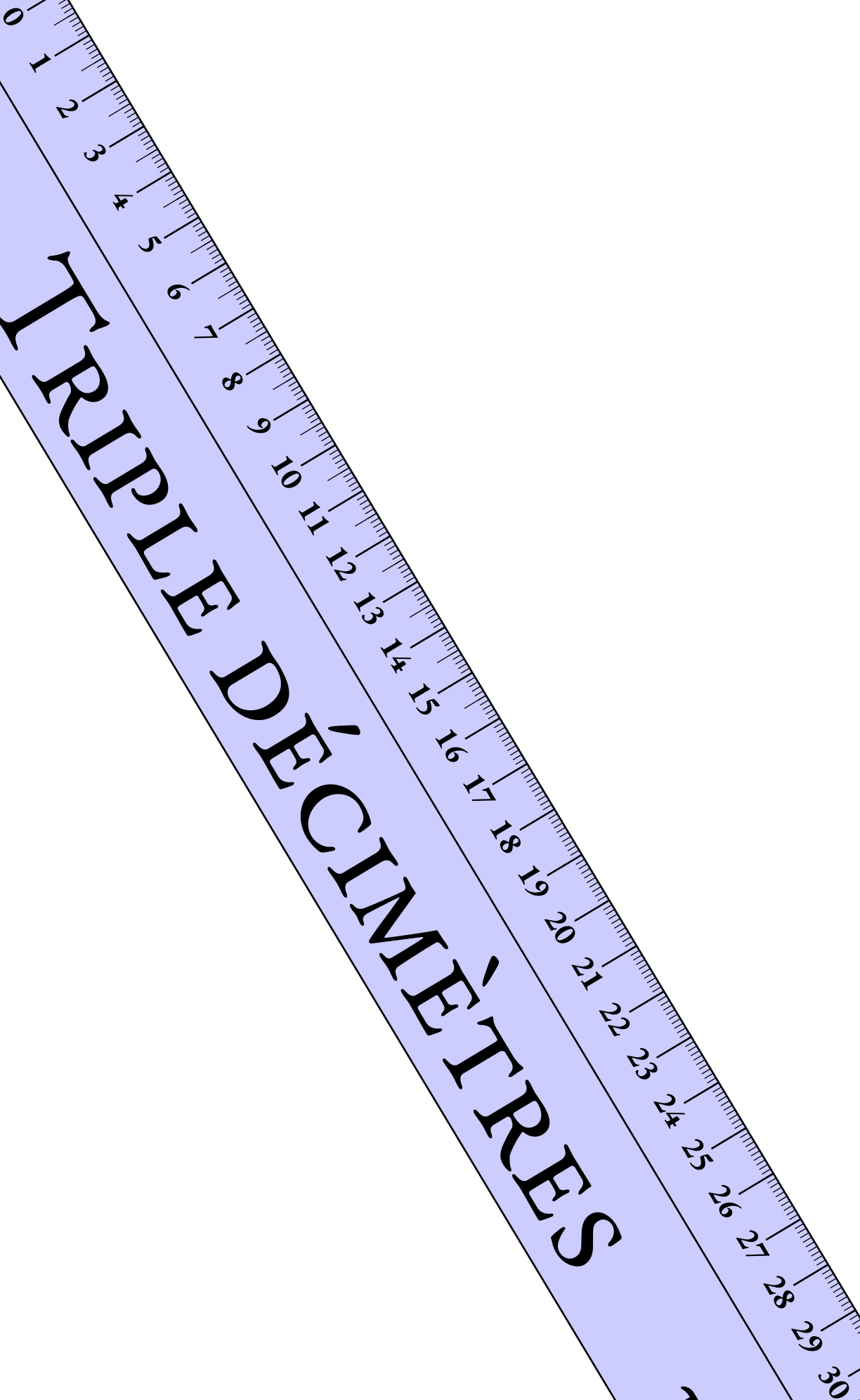

π

TRIPLE DÉCIMÈTRES

30 29 28 27 26 25 24 23 22 21 20 19 18 17 16 15 14 13 12 11 10 9 8 7 6 5 4 3 2 1 0

π

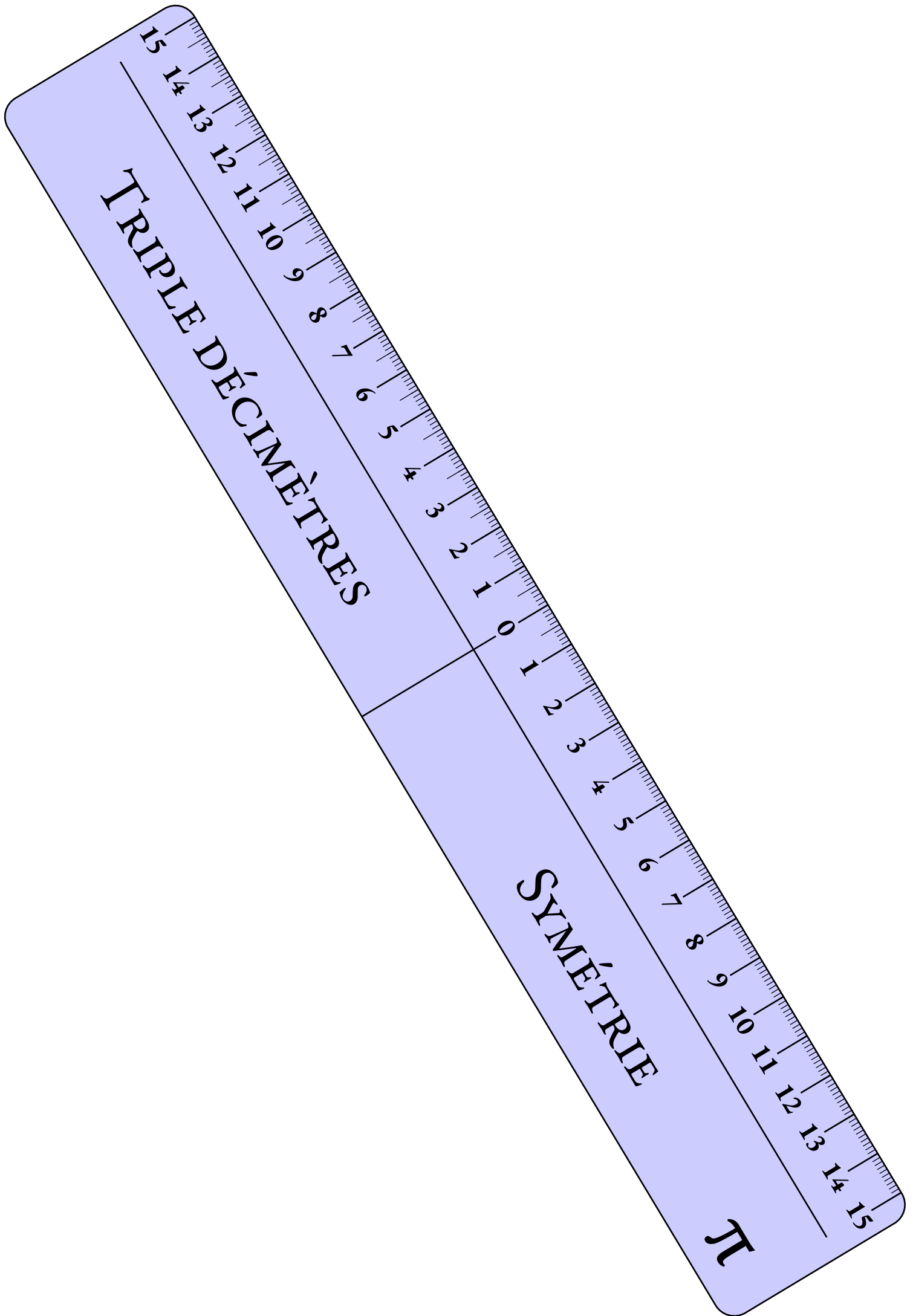

TRIPLE DÉCIMÈTRES

SYMÉTRIE

π

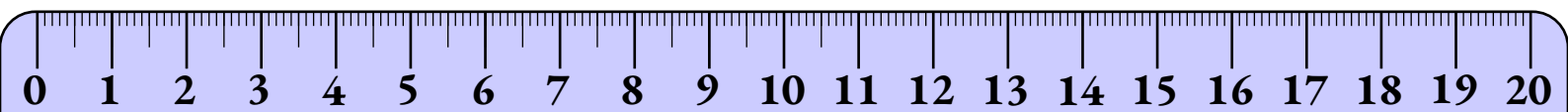

DOUBLE DÉCIMÈTRES π

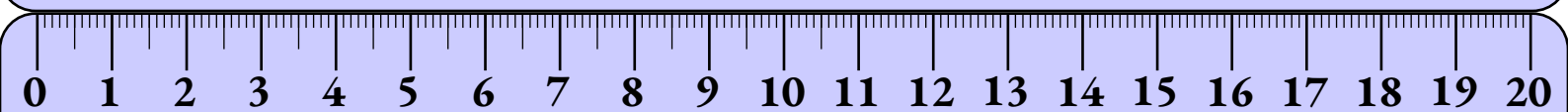

DOUBLE DÉCIMÈTRES π

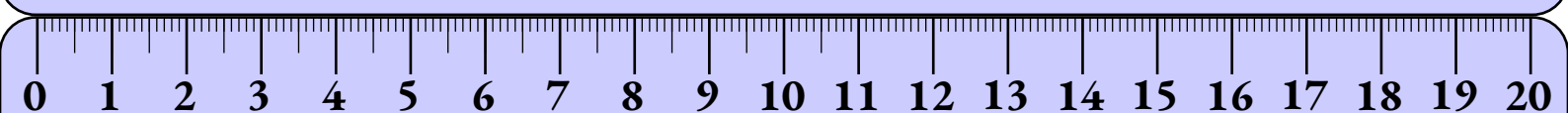

DOUBLE DÉCIMÈTRES π

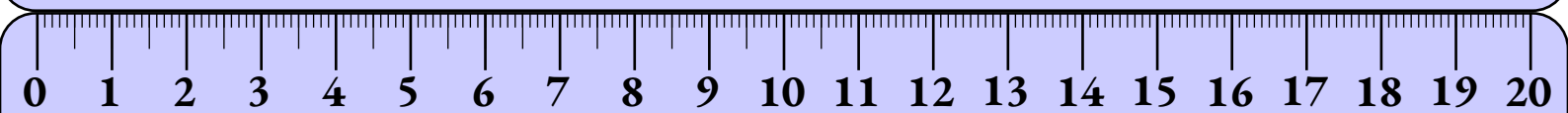

DOUBLE DÉCIMÈTRES π

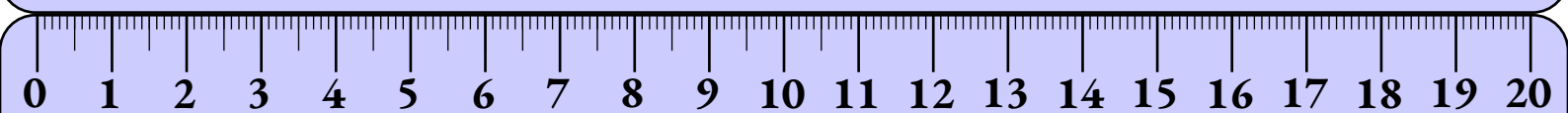

DOUBLE DÉCIMÈTRES π

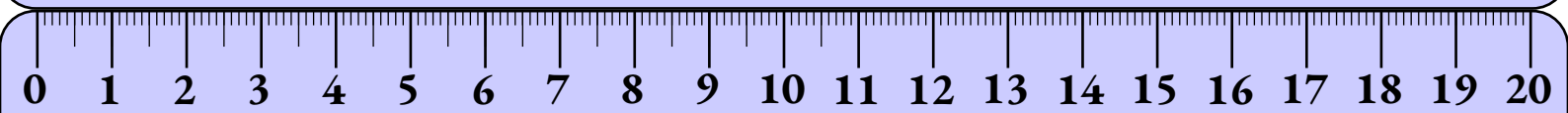

DOUBLE DÉCIMÈTRES π

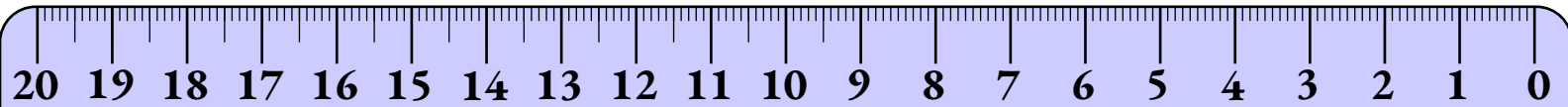

DOUBLE DÉCIMÈTRES π

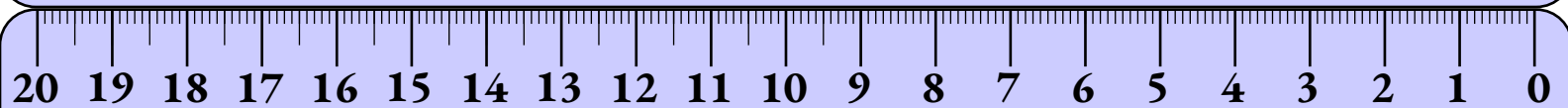

DOUBLE DÉCIMÈTRES π

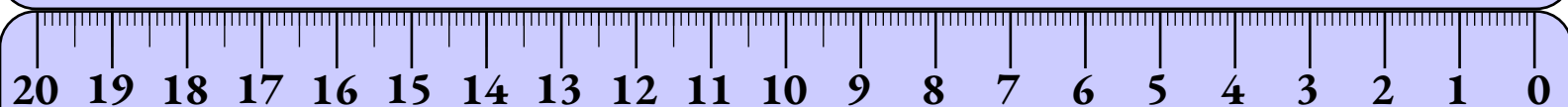

DOUBLE DÉCIMÈTRES π

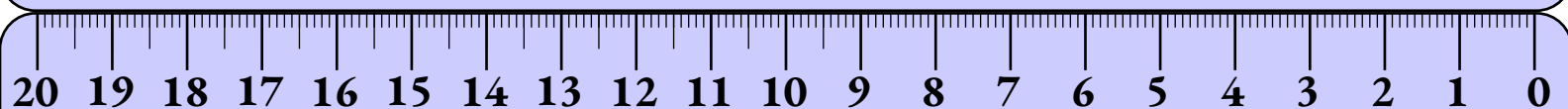

DOUBLE DÉCIMÈTRES π

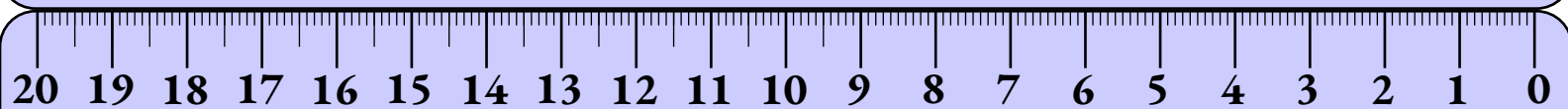

DOUBLE DÉCIMÈTRES π

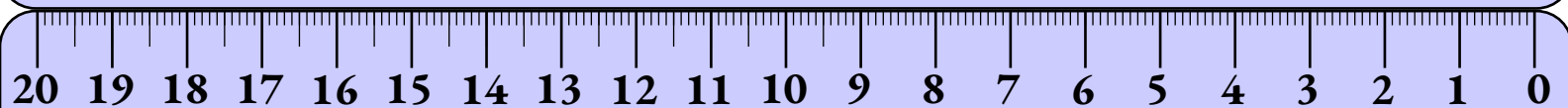

DOUBLE DÉCIMÈTRES π



DOUBLE DÉCIMÈTRES SYMÉTRIE π

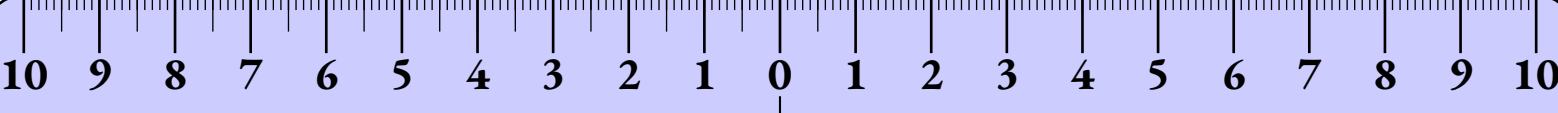

DOUBLE DÉCIMÈTRES SYMÉTRIE π

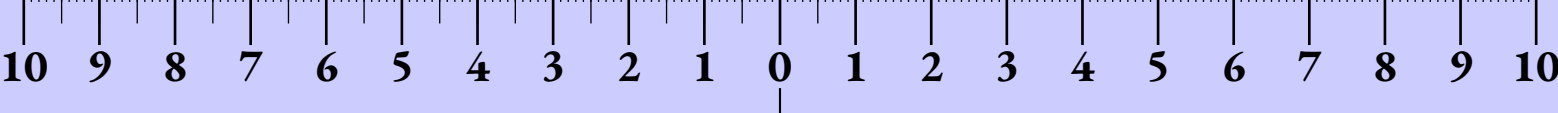

DOUBLE DÉCIMÈTRES SYMÉTRIE π

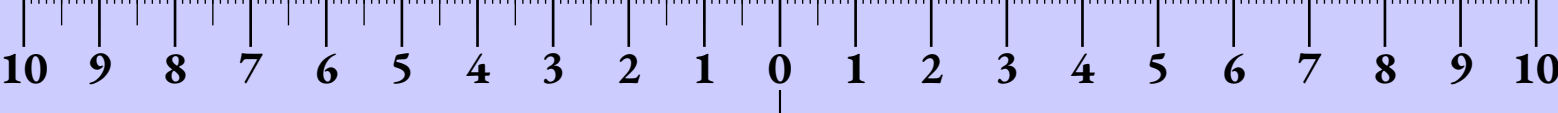

DOUBLE DÉCIMÈTRES SYMÉTRIE π

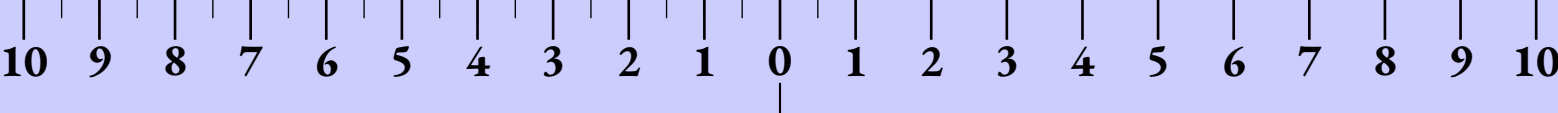

DOUBLE DÉCIMÈTRES SYMÉTRIE π

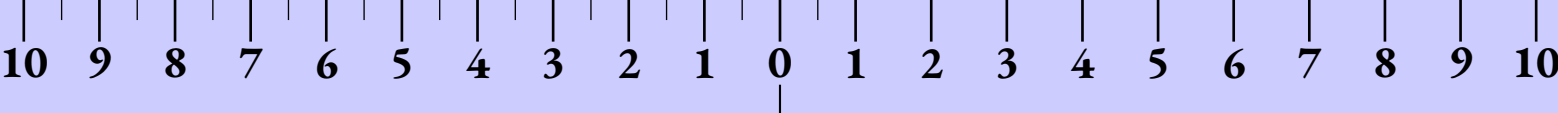

DOUBLE DÉCIMÈTRES SYMÉTRIE π

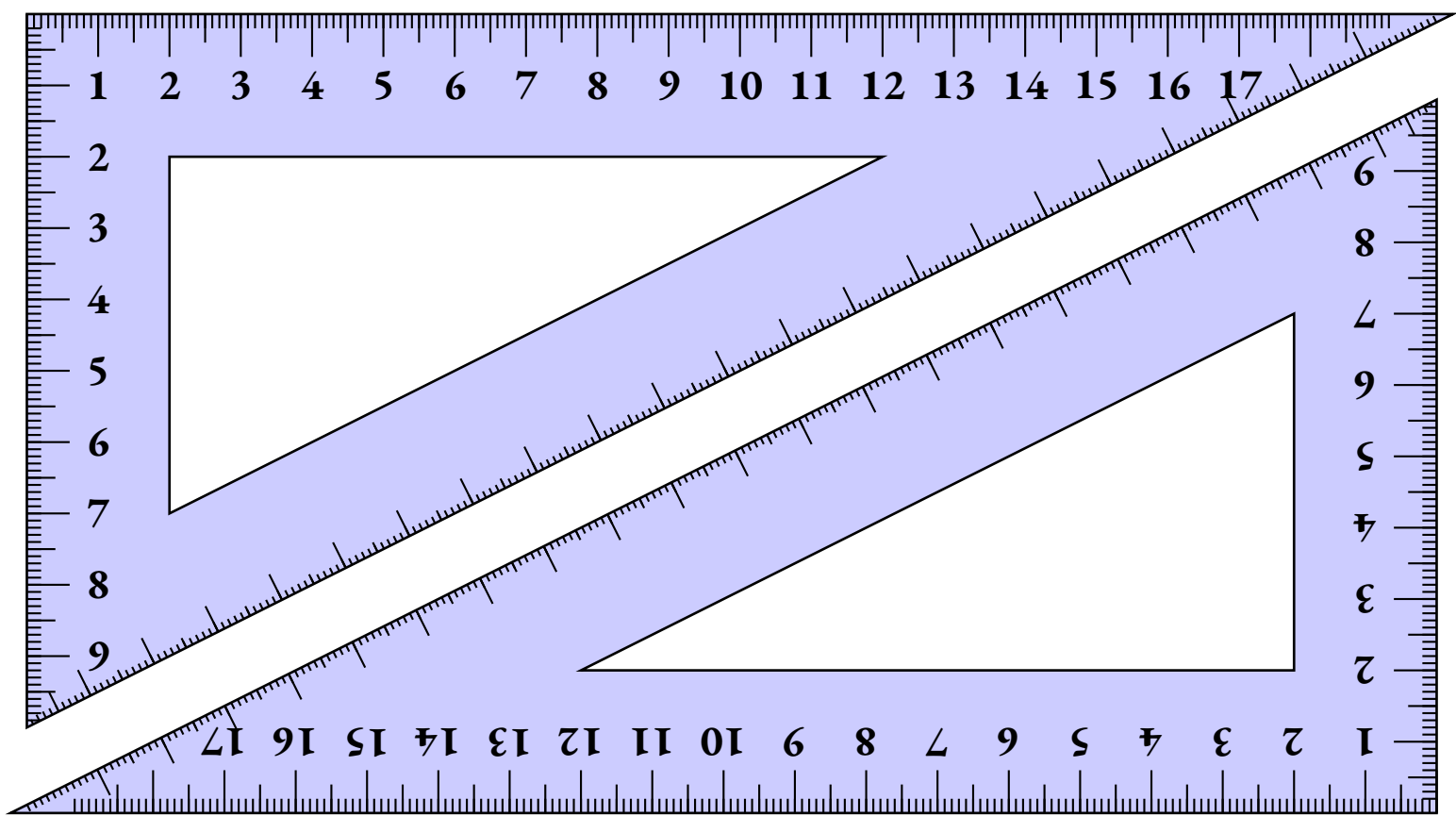
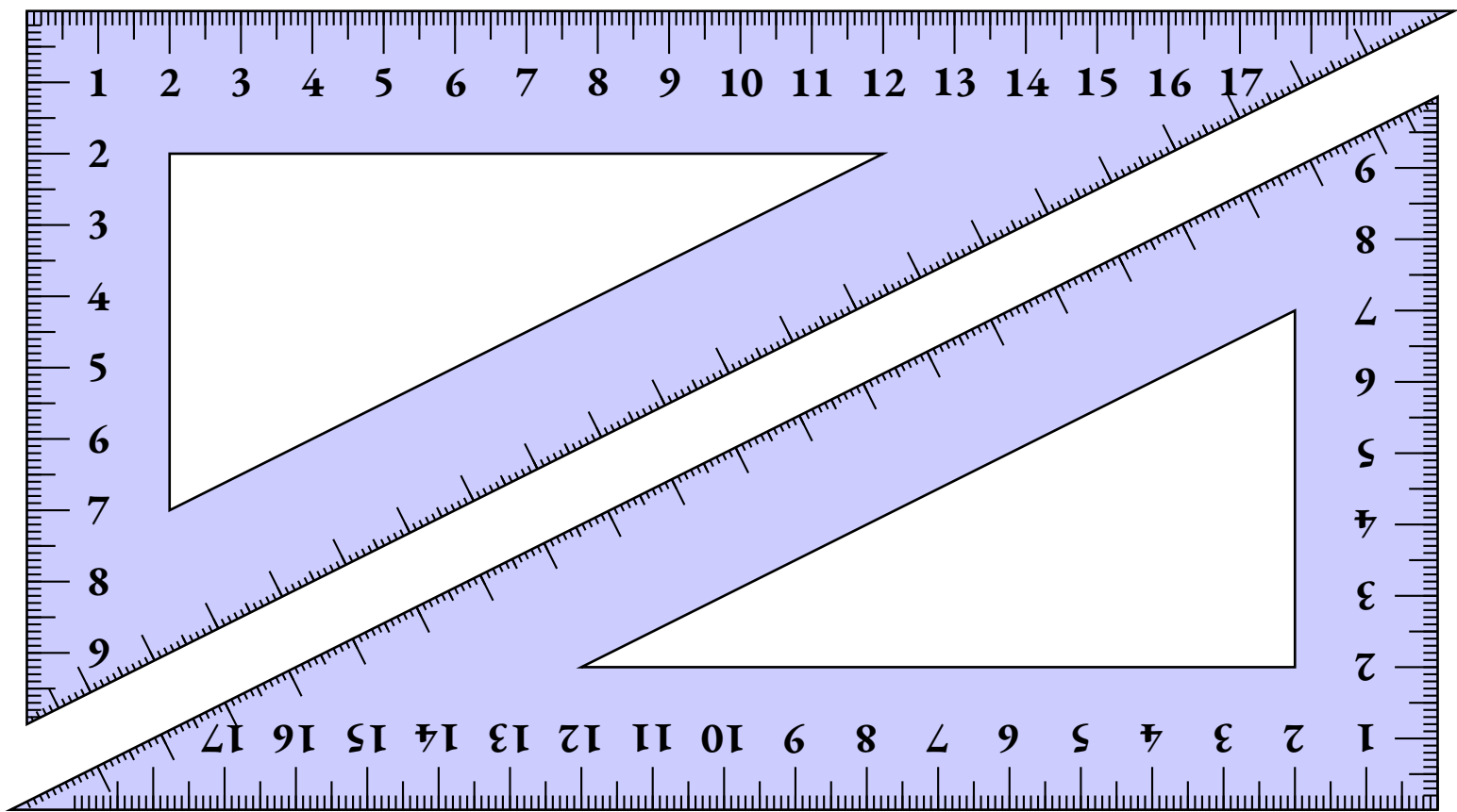

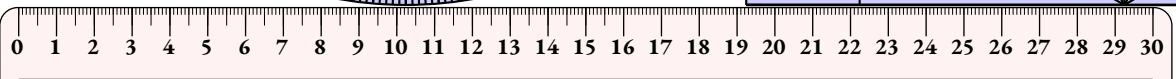
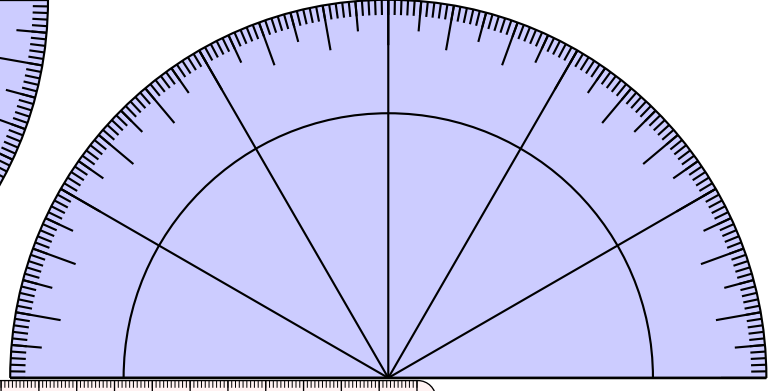
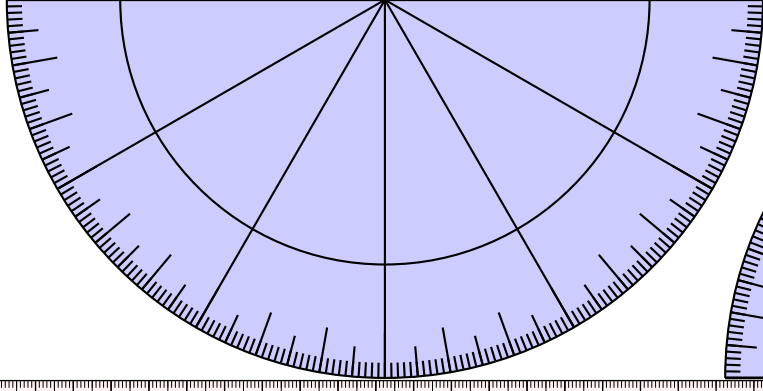
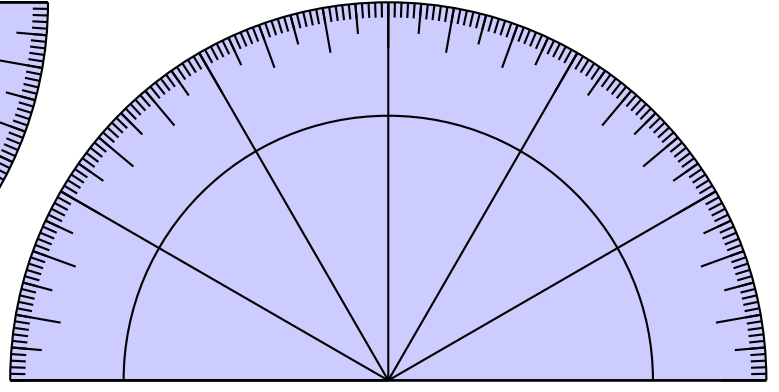
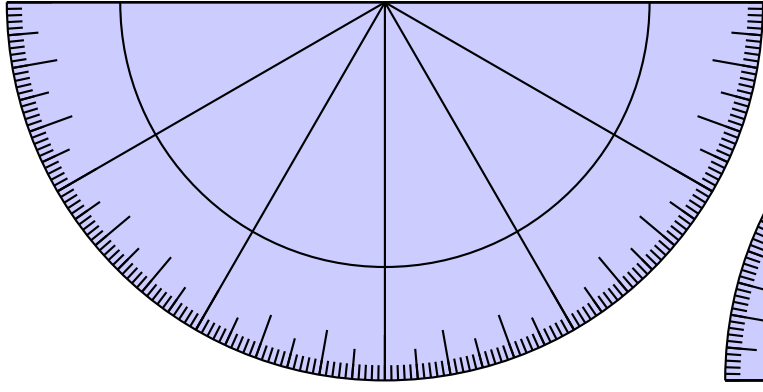
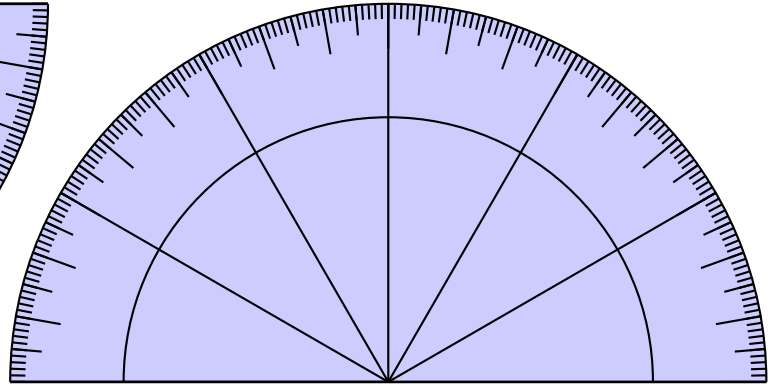
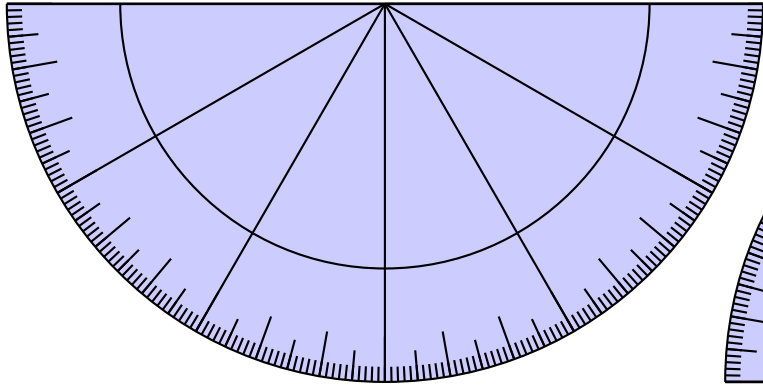
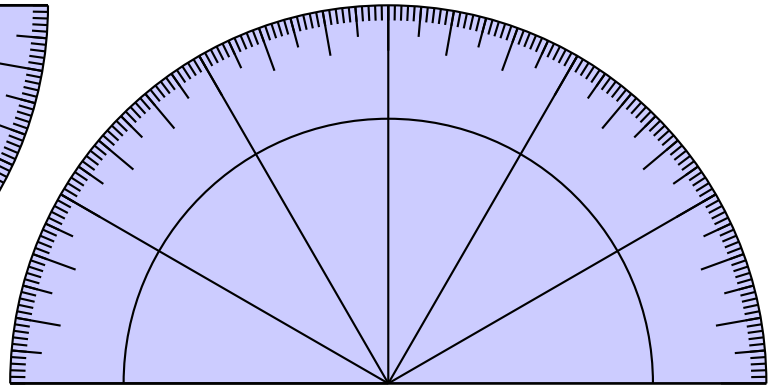
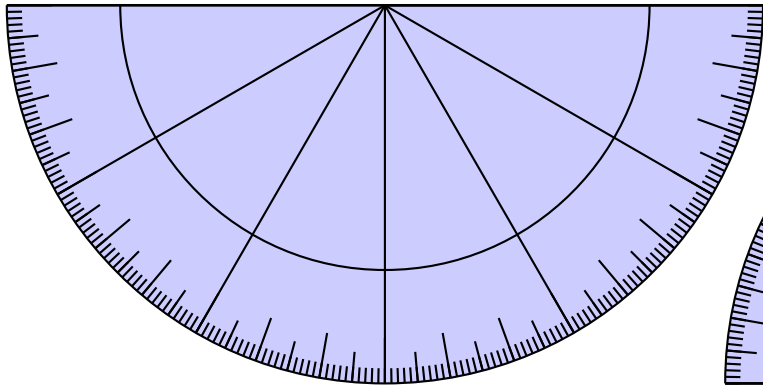
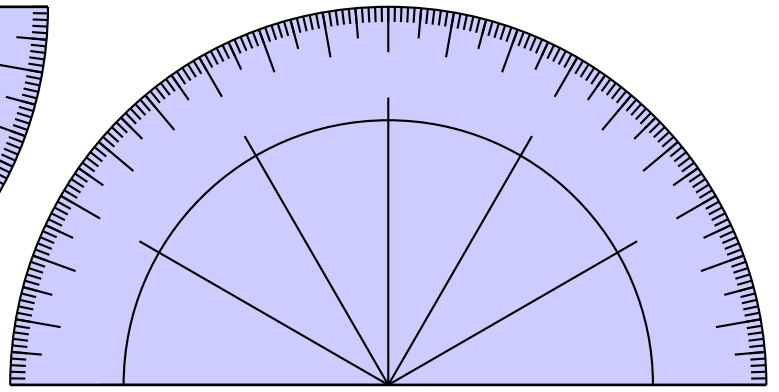
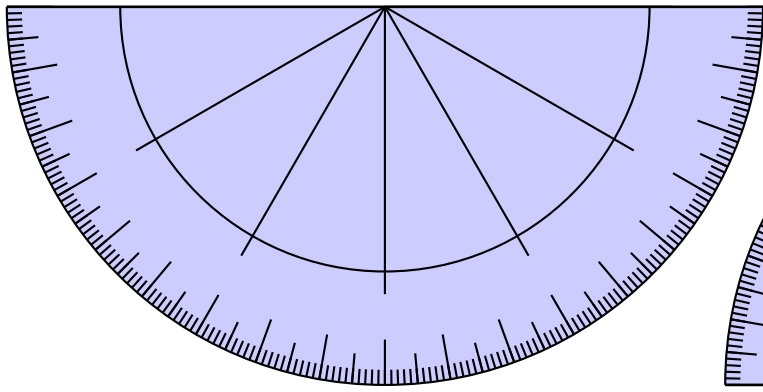

TRIPLE DÉCIMÈTRES

π



TRIPLE DÉCIMÈTRES π

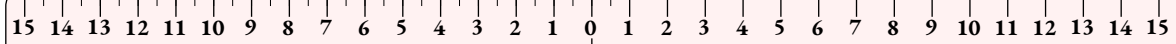

TRIPLE DÉCIMÈTRES

SYMÉTRIE

π

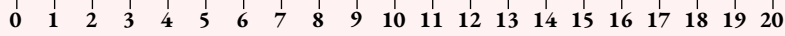

DOUBLE DÉCIMÈTRES π

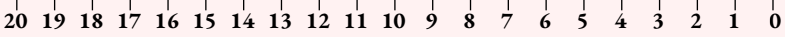

DOUBLE DÉCIMÈTRES π

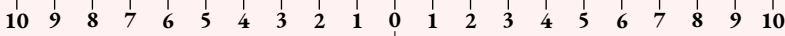

DOUBLE DÉCIMÈTRES

SYMÉTRIE

π

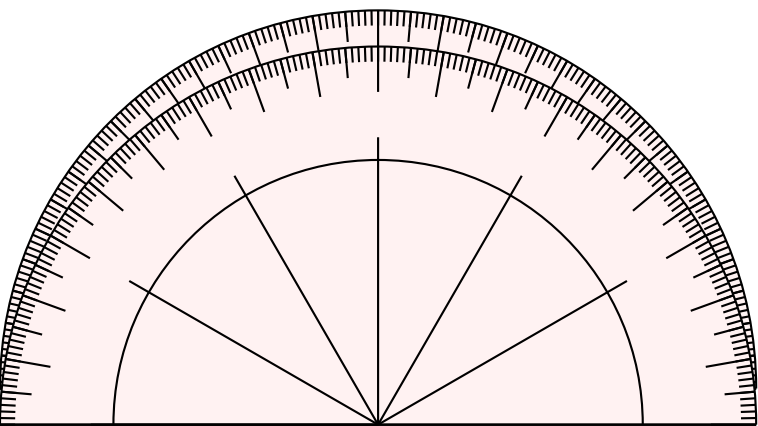
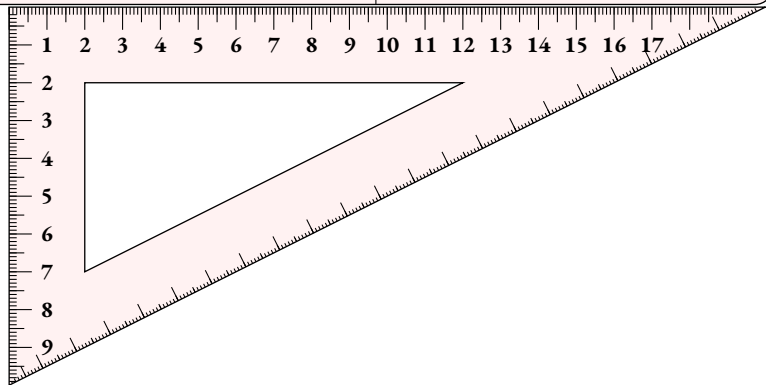

TRIPLE DÉCIMÈTRES

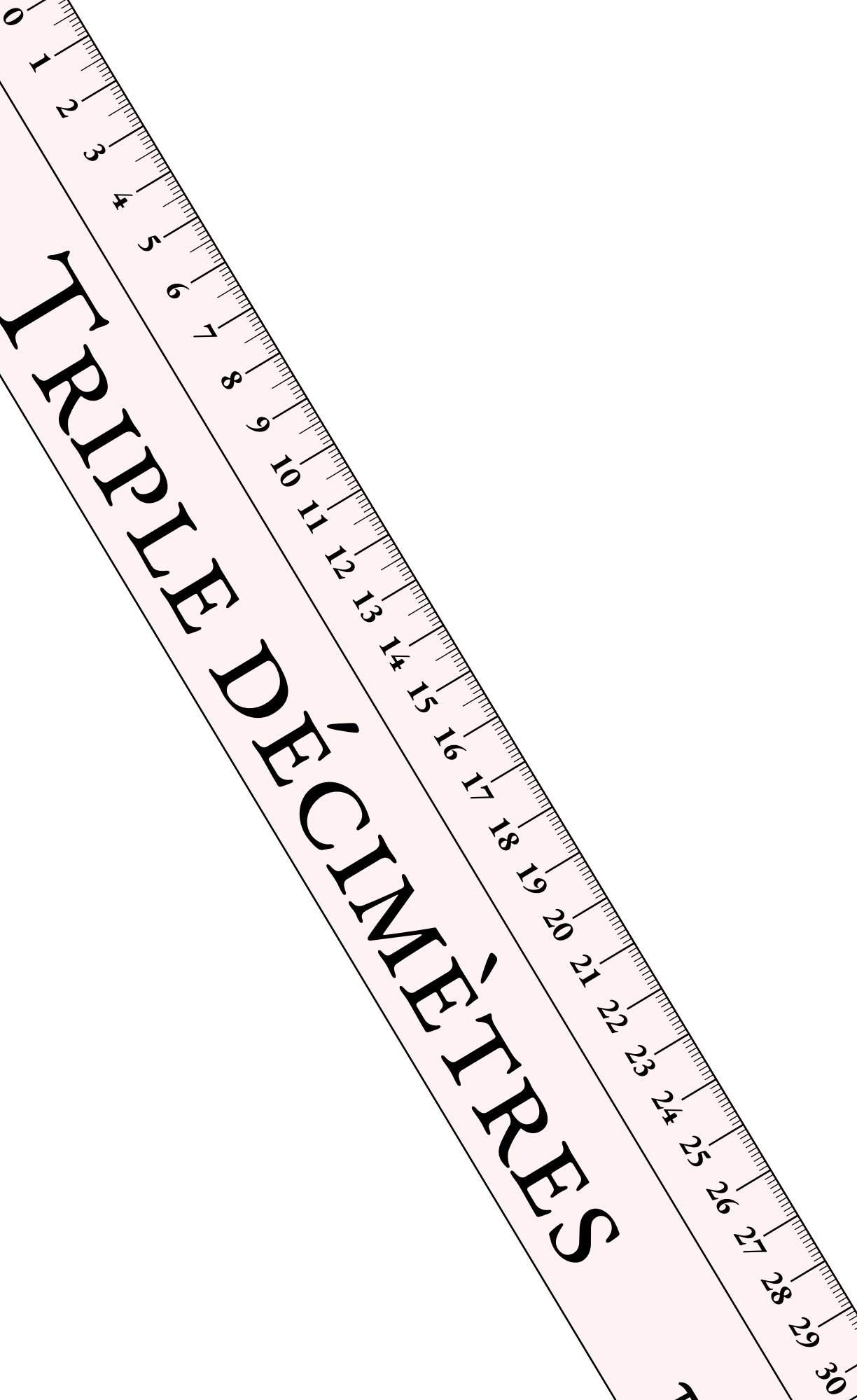

π

TRIPLE DÉCIMÈTRES

π

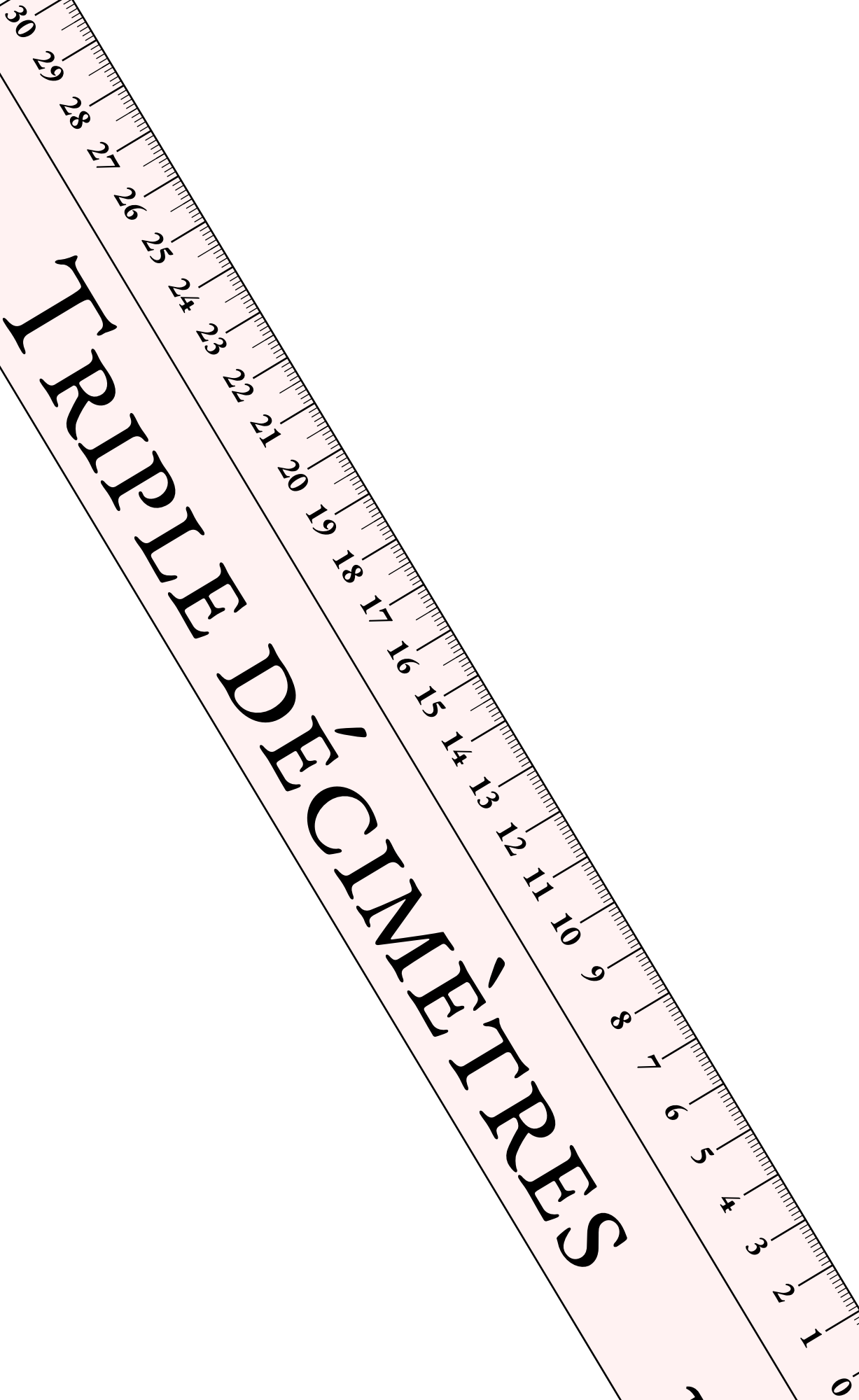

TRIPLE DÉCIMÈTRES

SYMÉTRIE

π

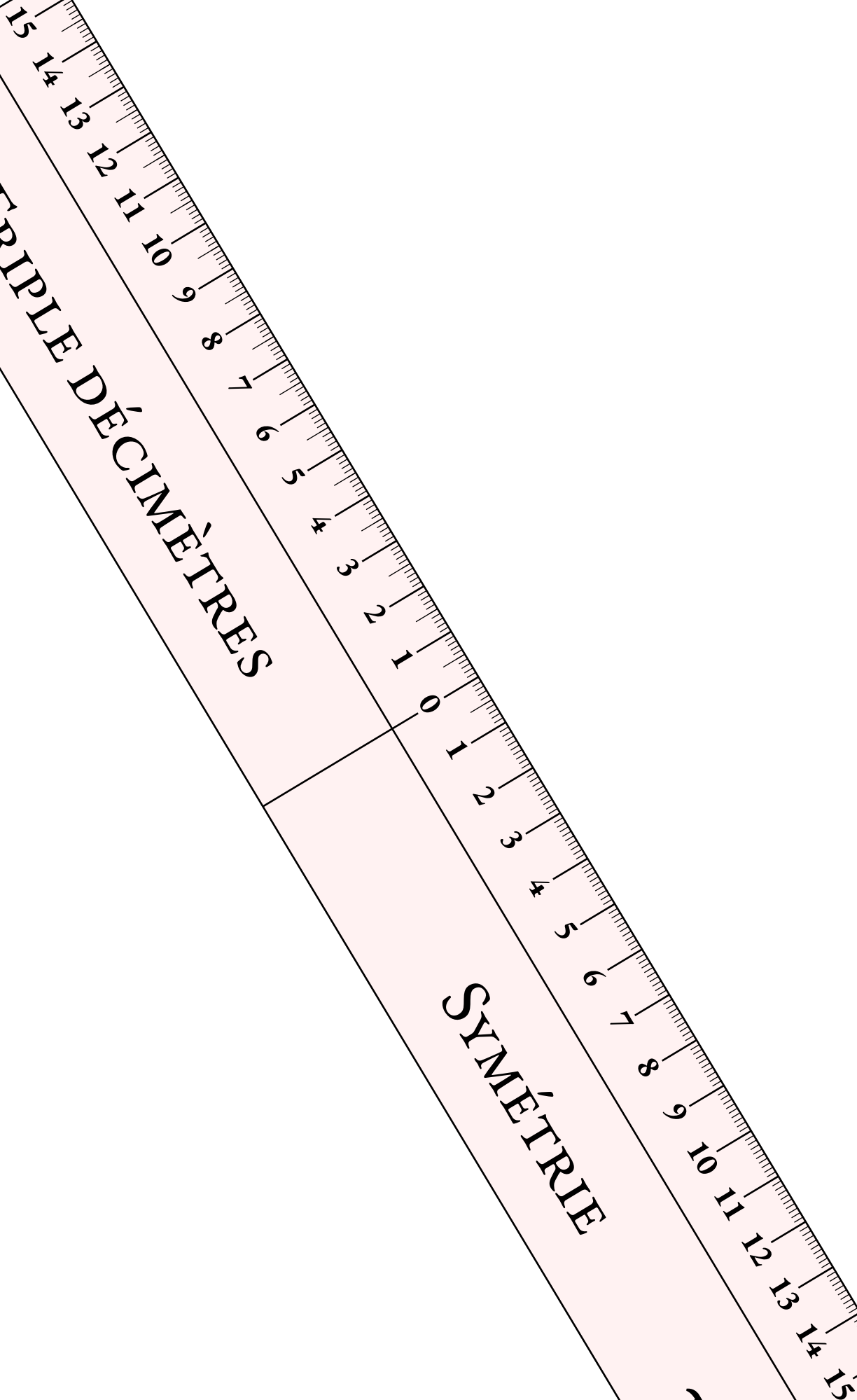

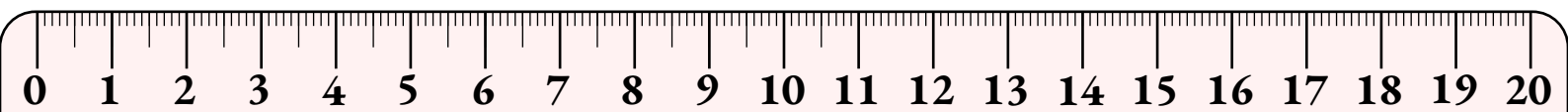

DOUBLE DÉCIMÈTRES π

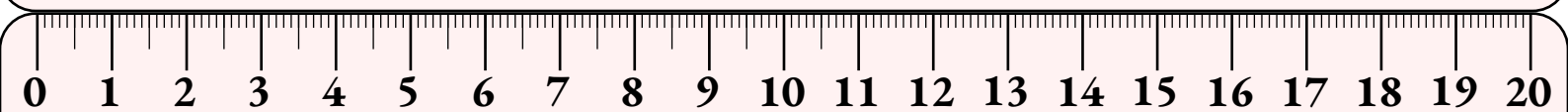

DOUBLE DÉCIMÈTRES π

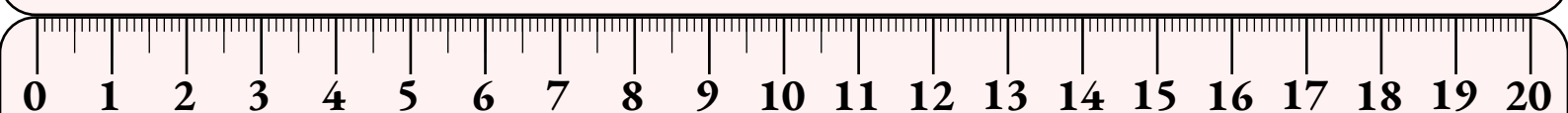

DOUBLE DÉCIMÈTRES π

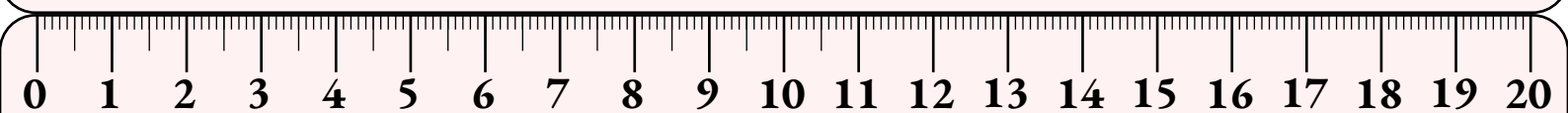

DOUBLE DÉCIMÈTRES π

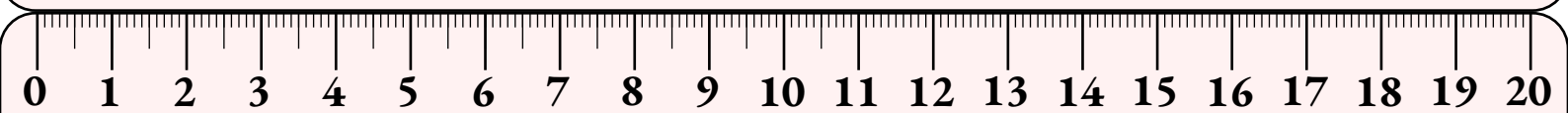

DOUBLE DÉCIMÈTRES π

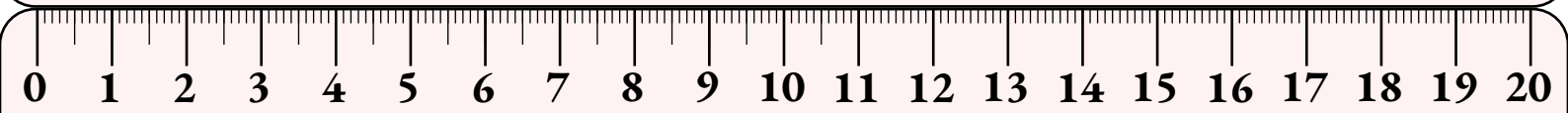

DOUBLE DÉCIMÈTRES π

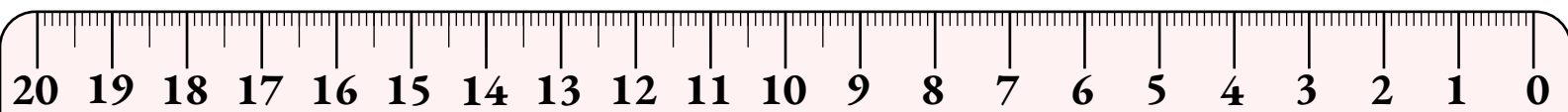

DOUBLE DÉCIMÈTRES π

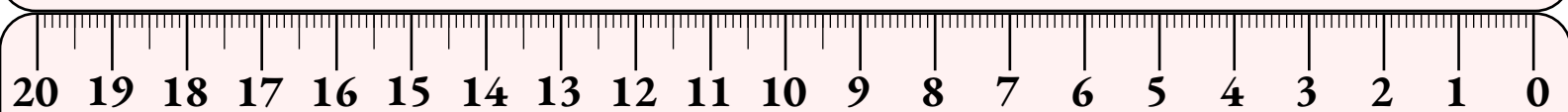

DOUBLE DÉCIMÈTRES π

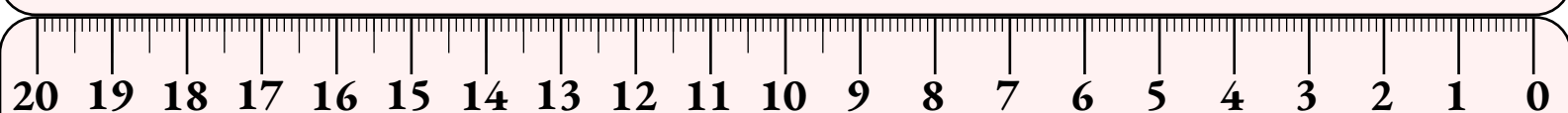

DOUBLE DÉCIMÈTRES π

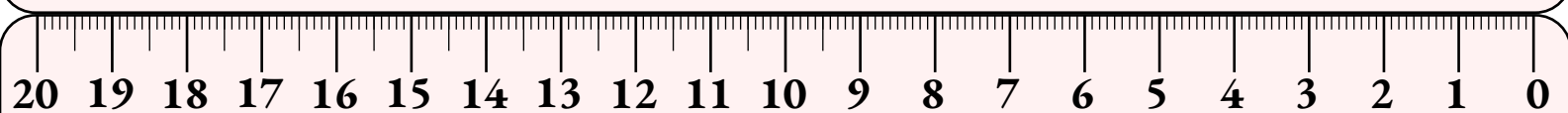

DOUBLE DÉCIMÈTRES π

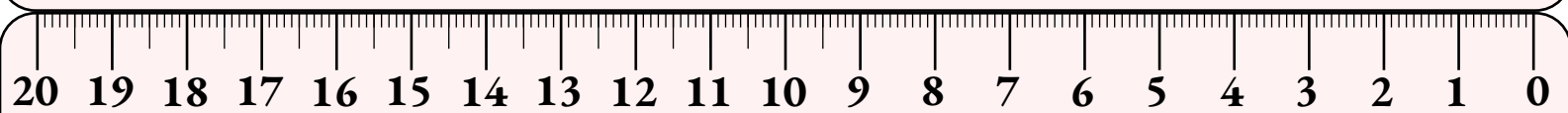

DOUBLE DÉCIMÈTRES π

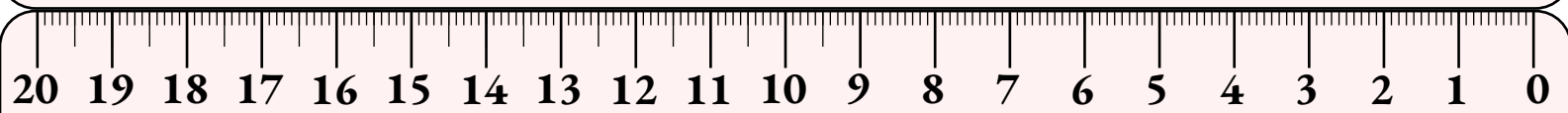

DOUBLE DÉCIMÈTRES π

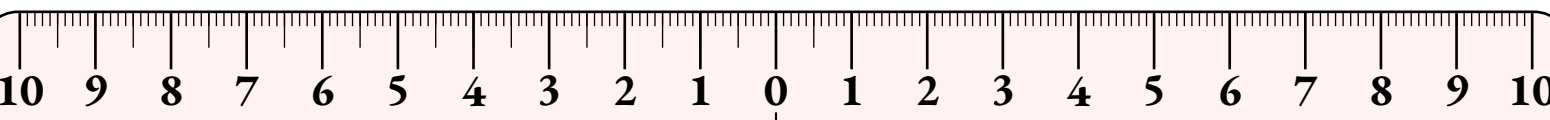

DOUBLE DÉCIMÈTRES SYMÉTRIE π

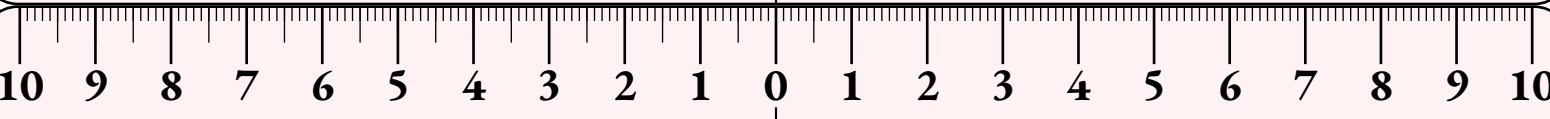

DOUBLE DÉCIMÈTRES SYMÉTRIE π

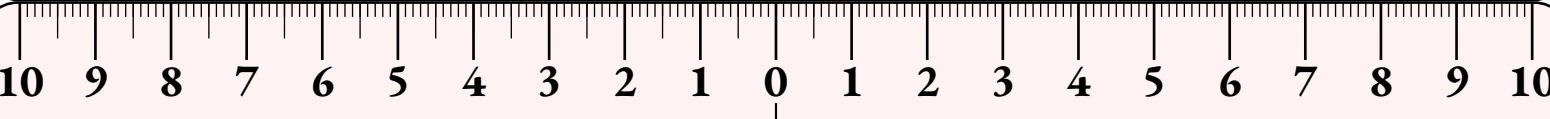

DOUBLE DÉCIMÈTRES SYMÉTRIE π

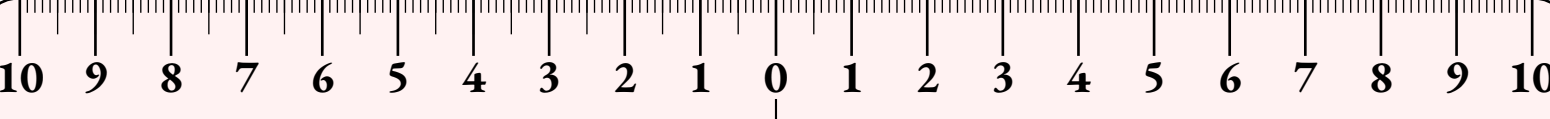

DOUBLE DÉCIMÈTRES SYMÉTRIE π

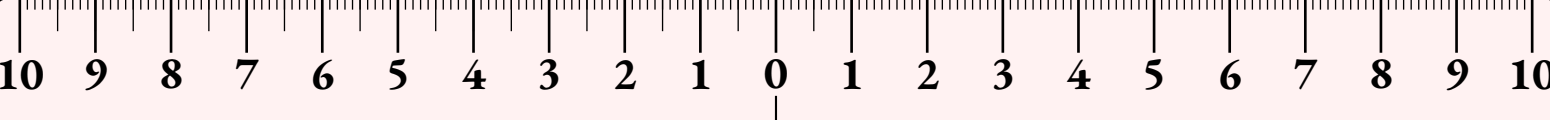

DOUBLE DÉCIMÈTRES SYMÉTRIE π

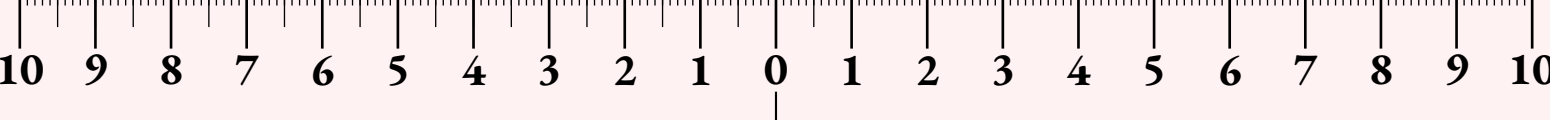

DOUBLE DÉCIMÈTRES SYMÉTRIE π

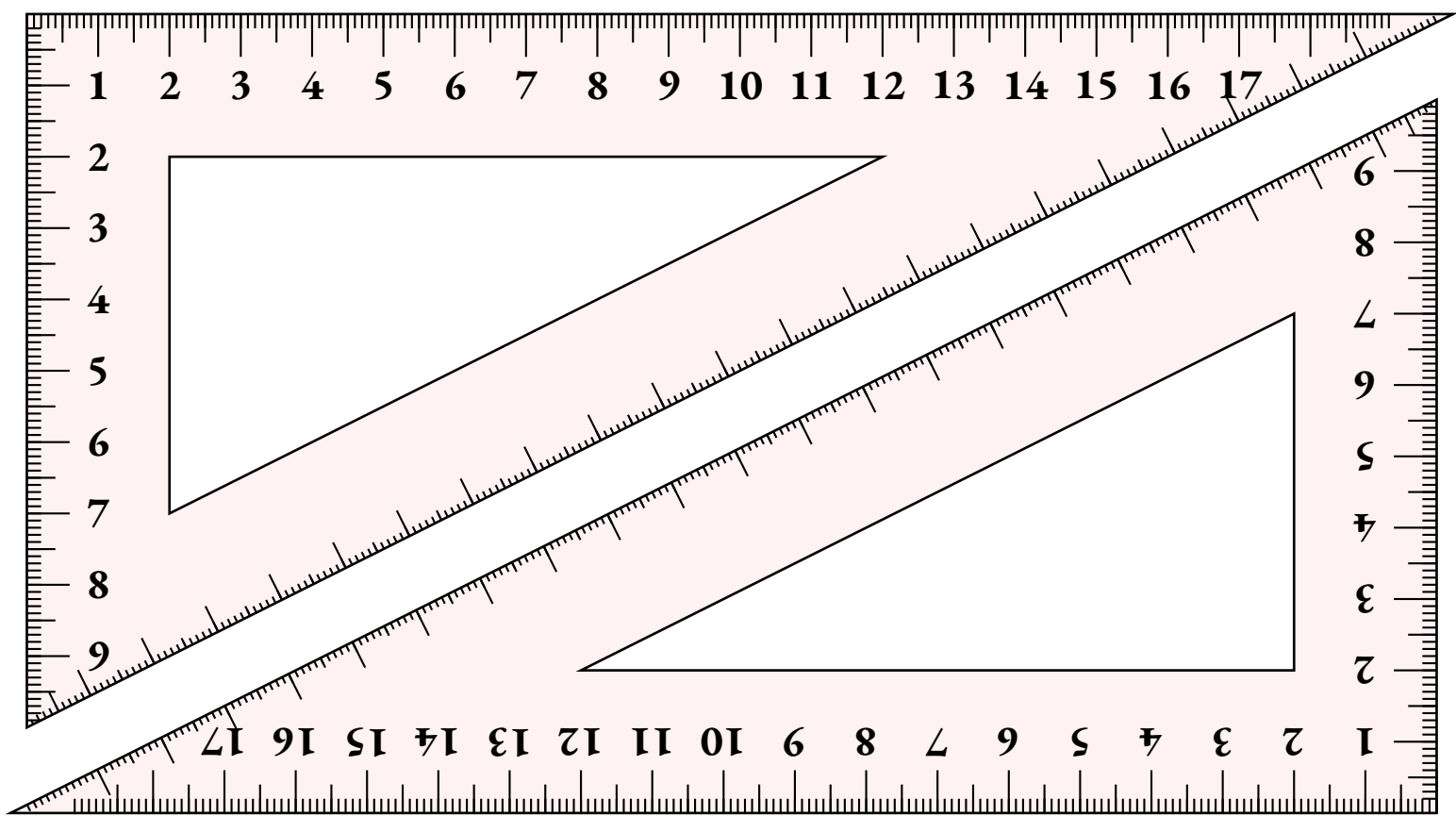
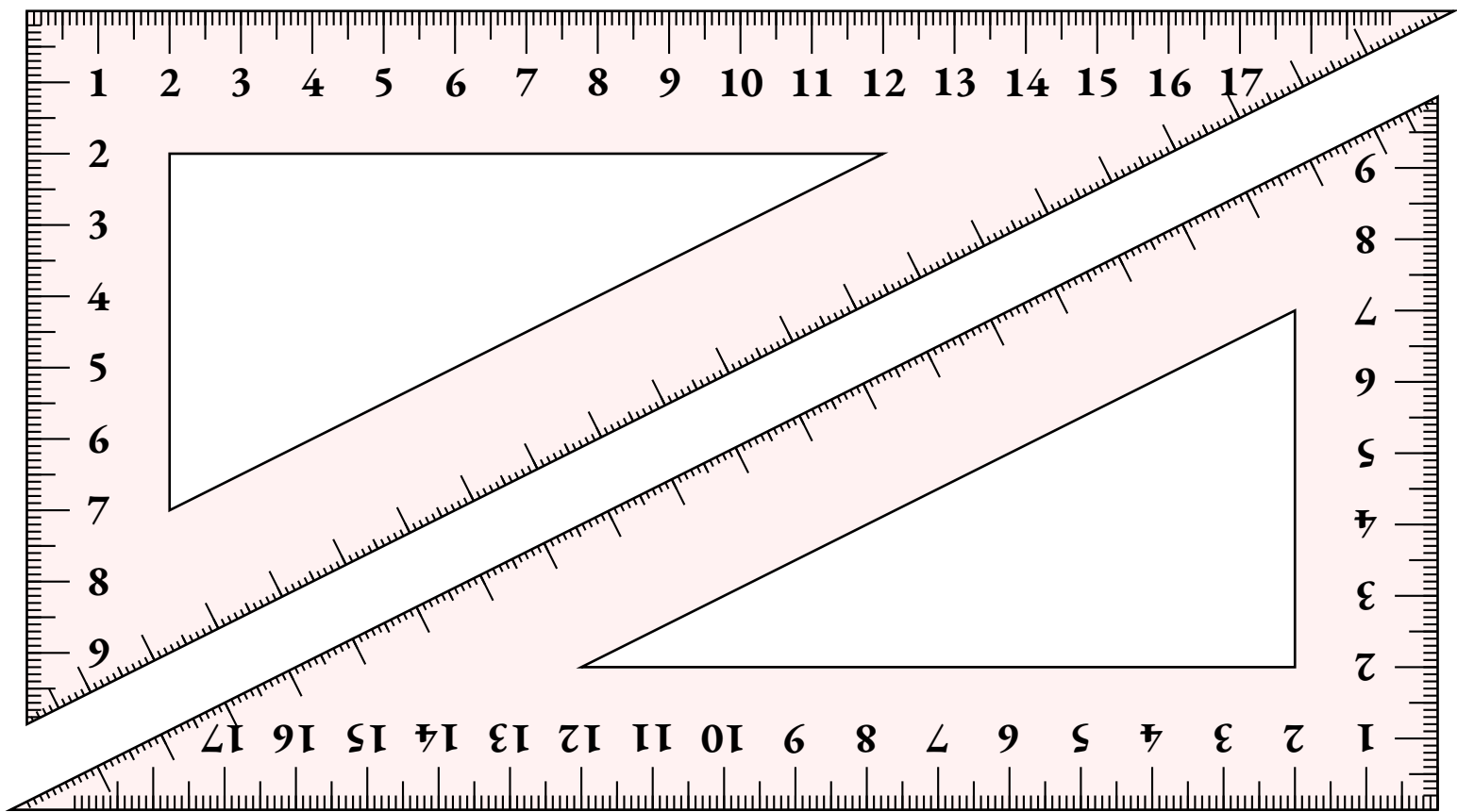

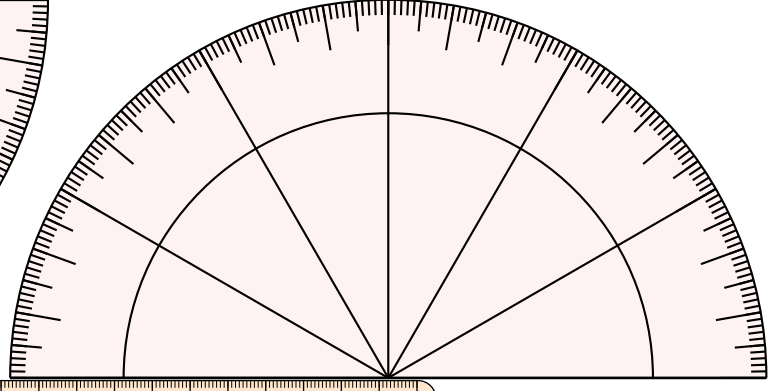
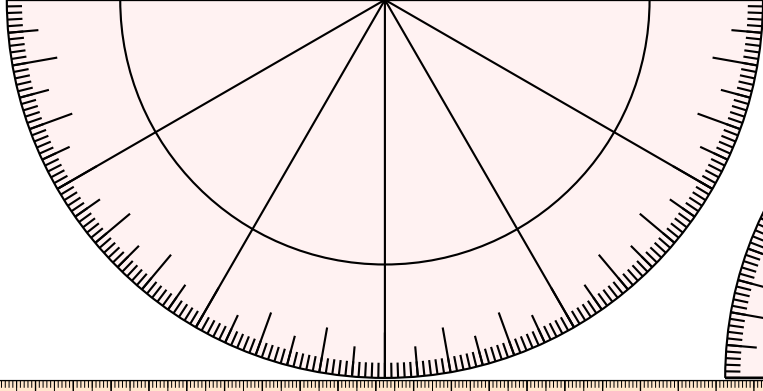
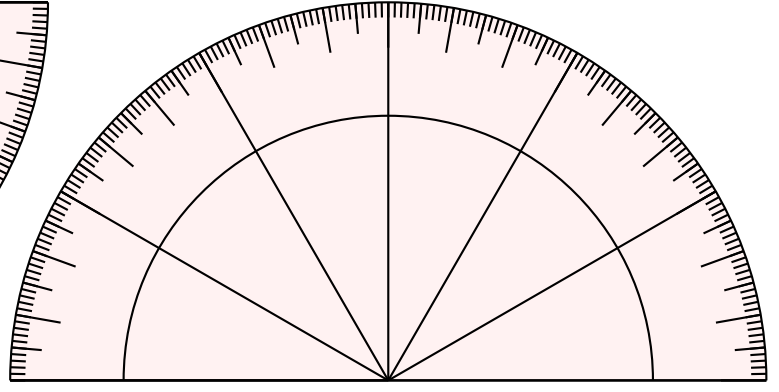
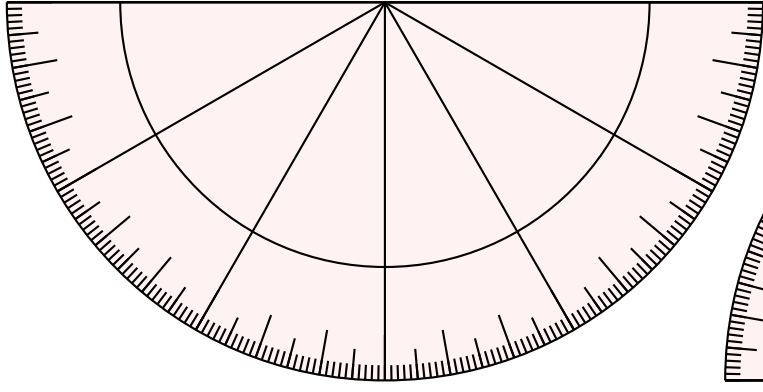
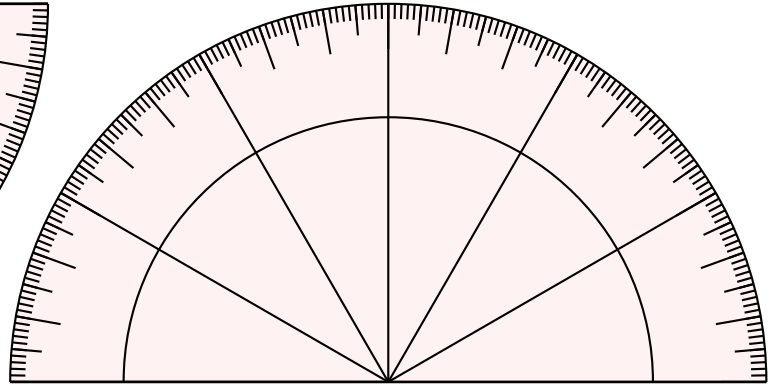
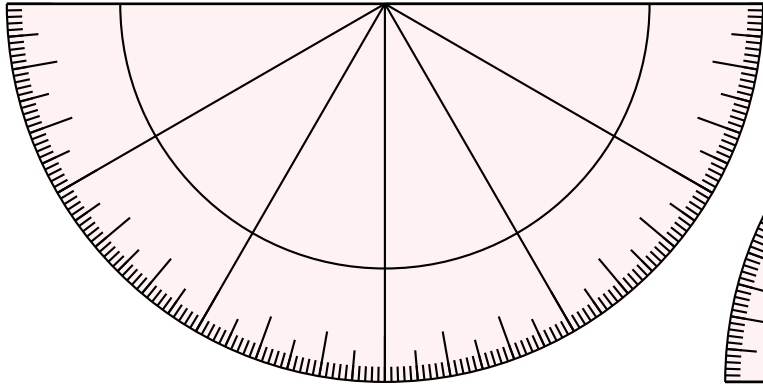
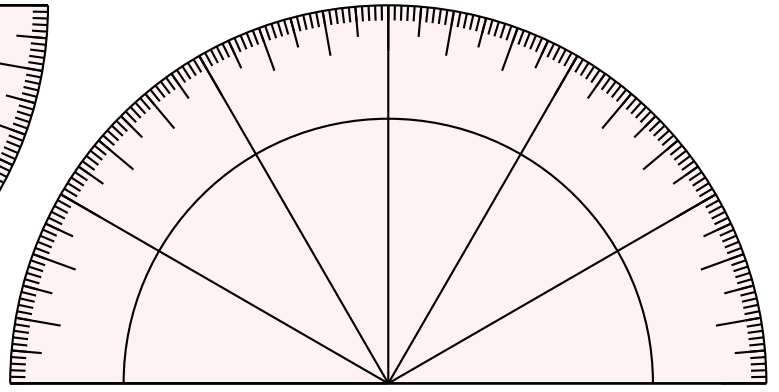
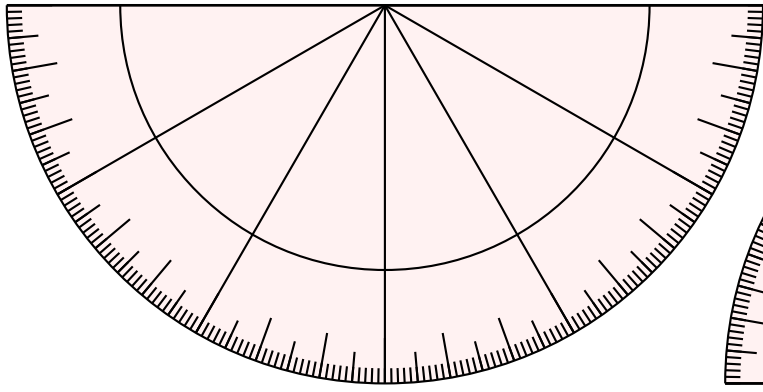
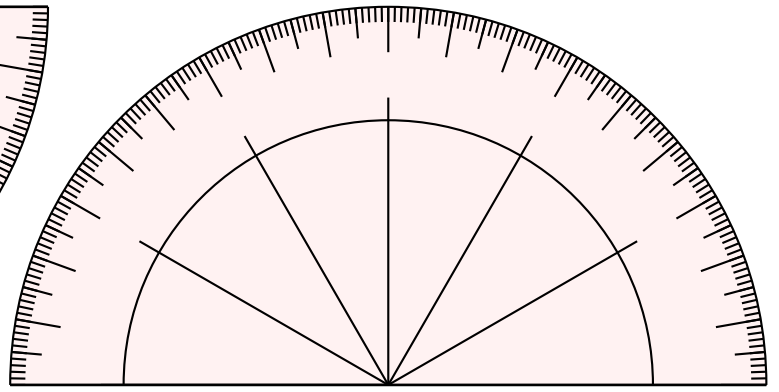
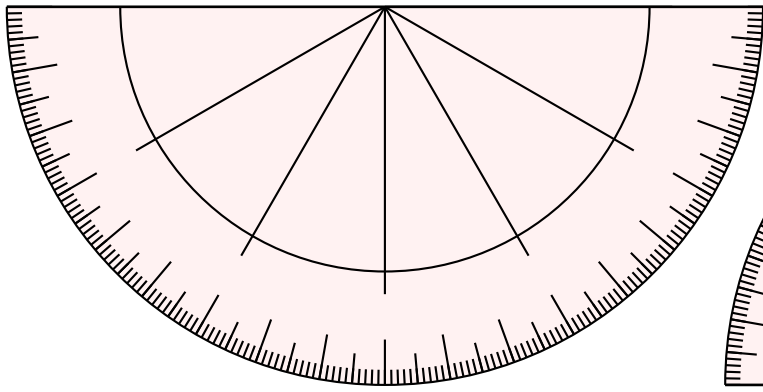

TRIPLE DÉCIMÈTRES

π



TRIPLE DÉCIMÈTRES π

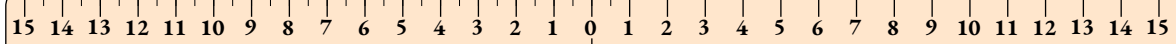

TRIPLE DÉCIMÈTRES

SYMÉTRIE

π

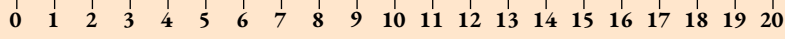

DOUBLE DÉCIMÈTRES π

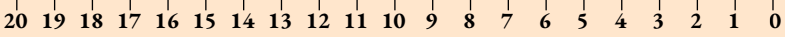

DOUBLE DÉCIMÈTRES π

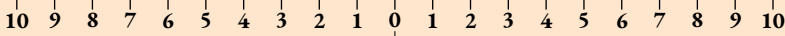

DOUBLE DÉCIMÈTRES

SYMÉTRIE

π

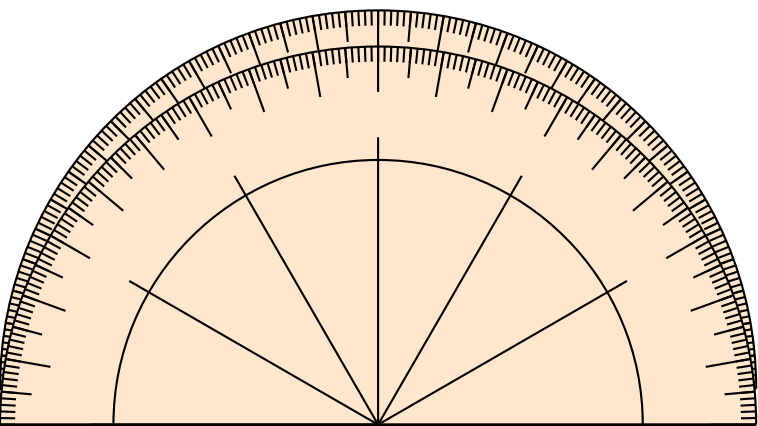
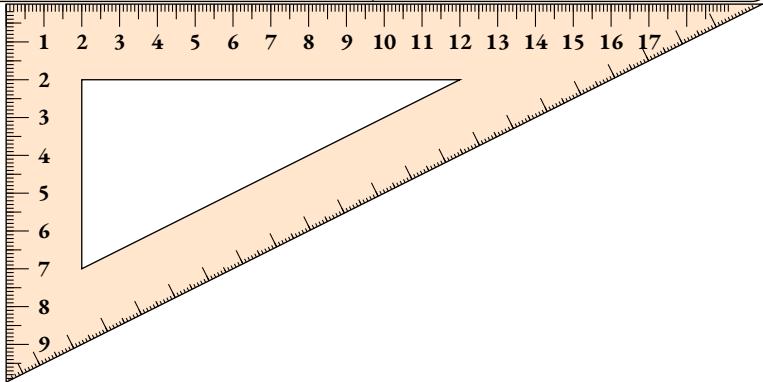

TRIPLE DÉCIMÈTRES

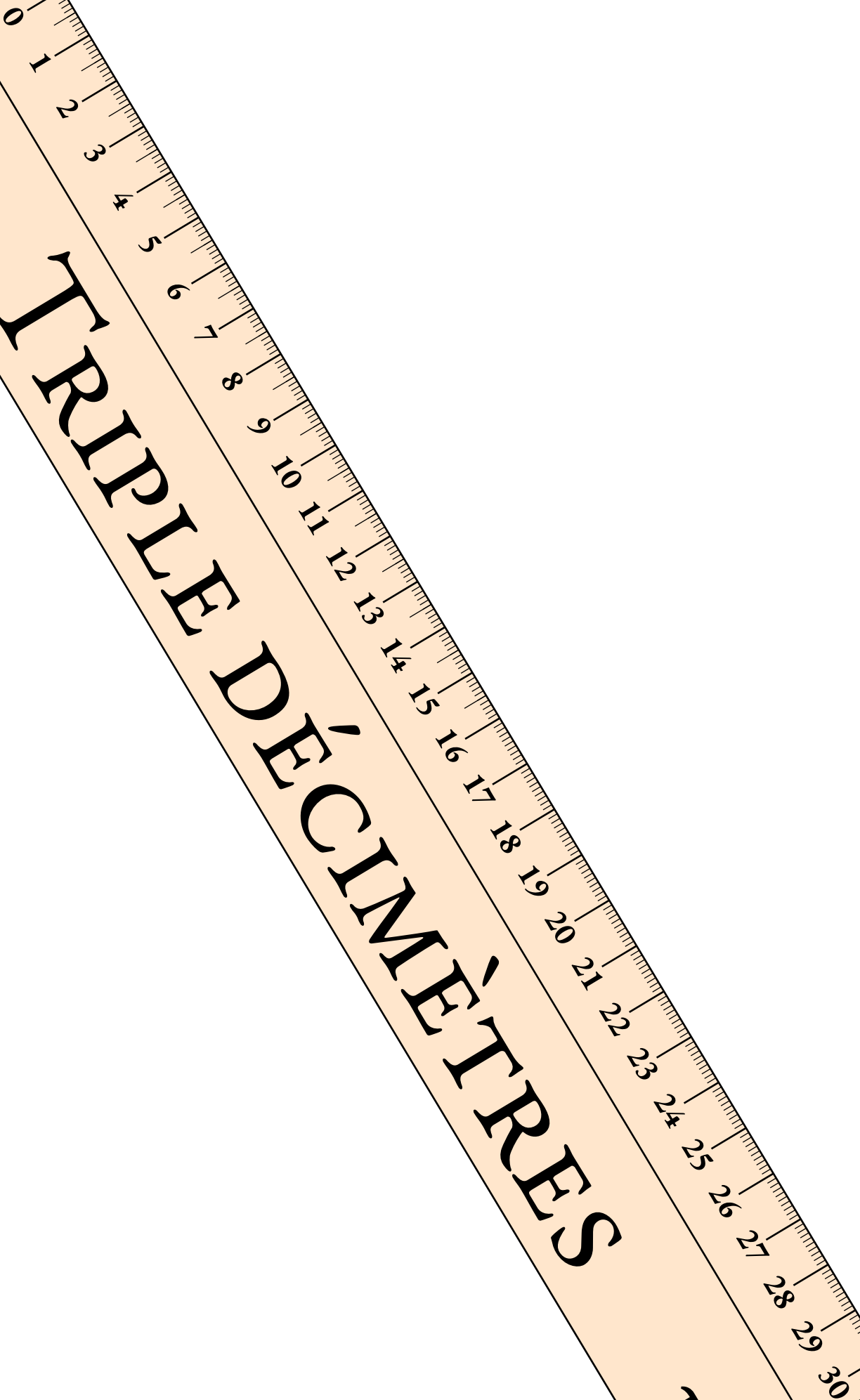

π

TRIPLE DÉCIMÈTRES

π

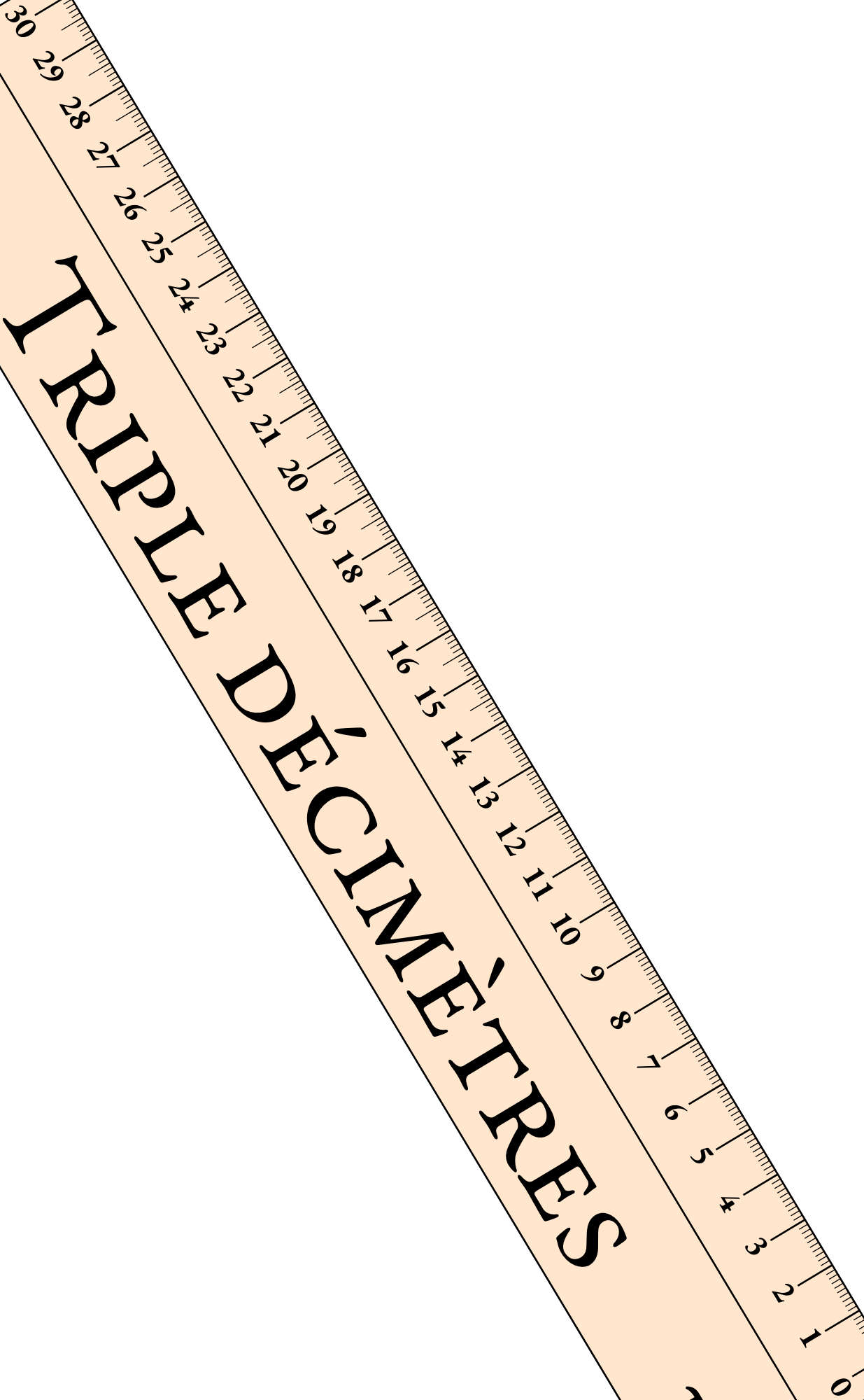

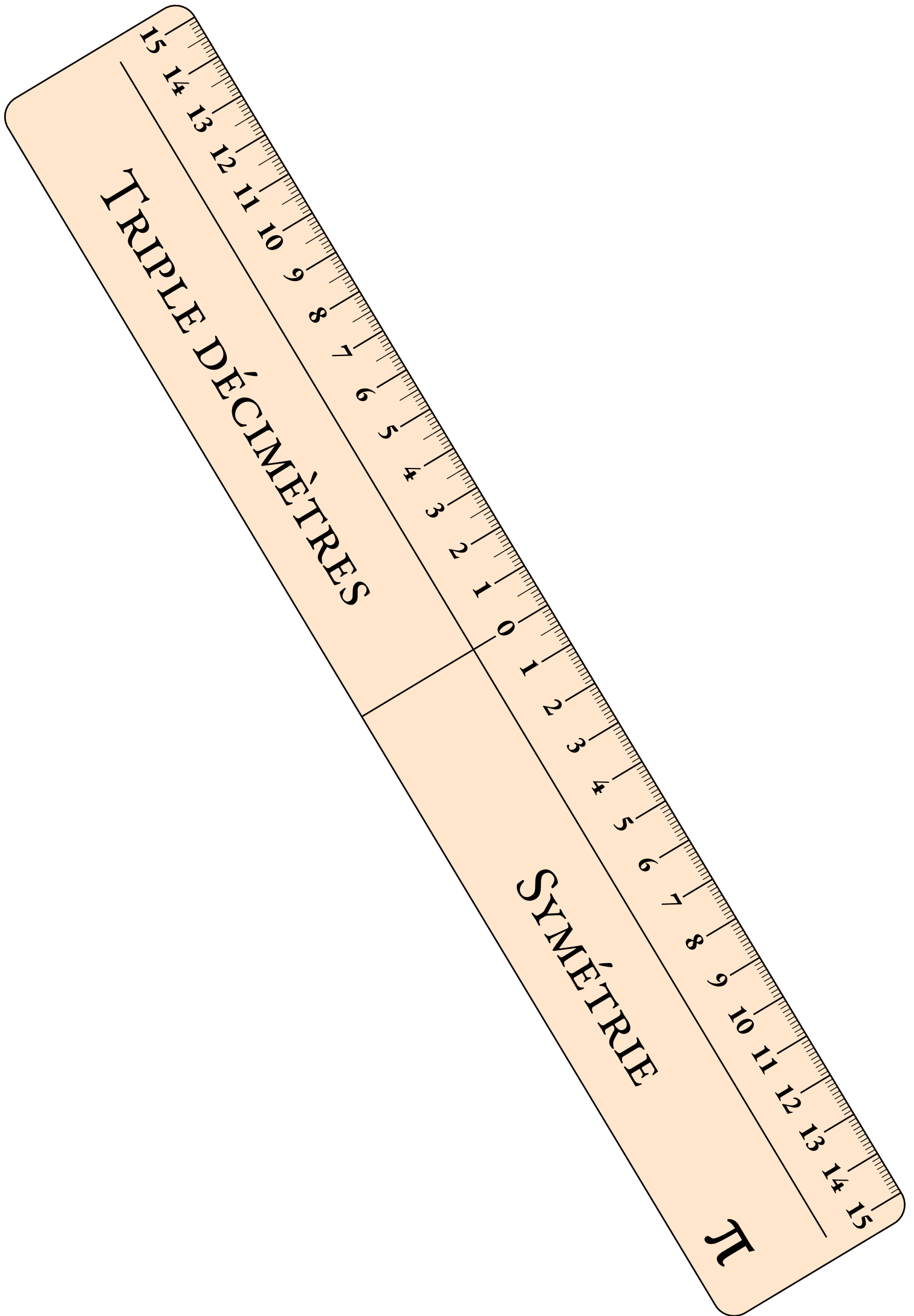

TRIPLE DÉCIMÈTRES

SYMÉTRIE

π

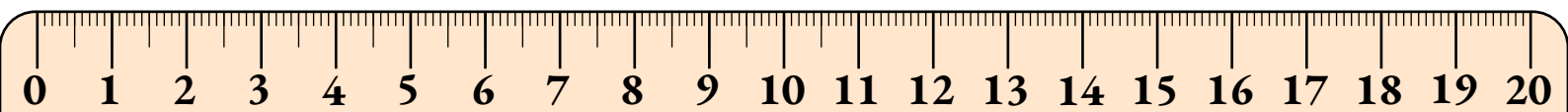

DOUBLE DÉCIMÈTRES π

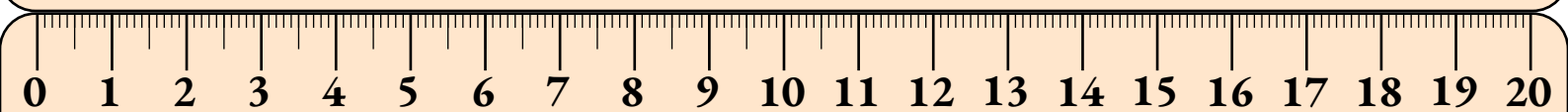

DOUBLE DÉCIMÈTRES π

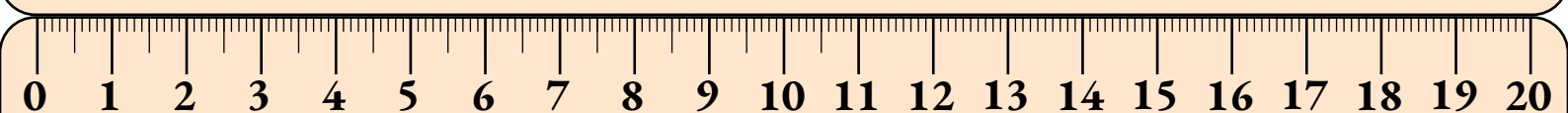

DOUBLE DÉCIMÈTRES π

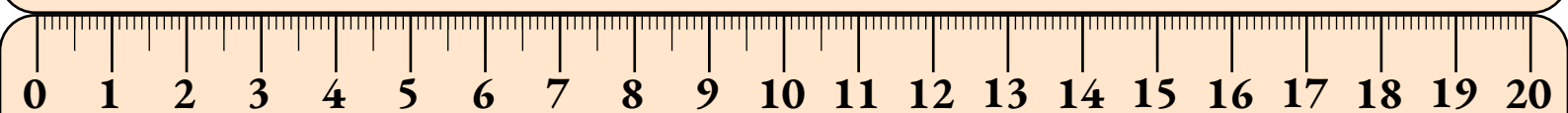

DOUBLE DÉCIMÈTRES π

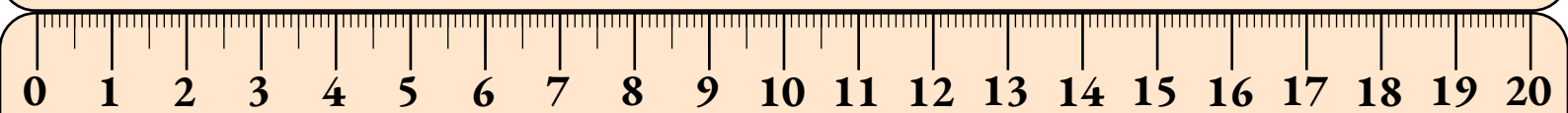

DOUBLE DÉCIMÈTRES π

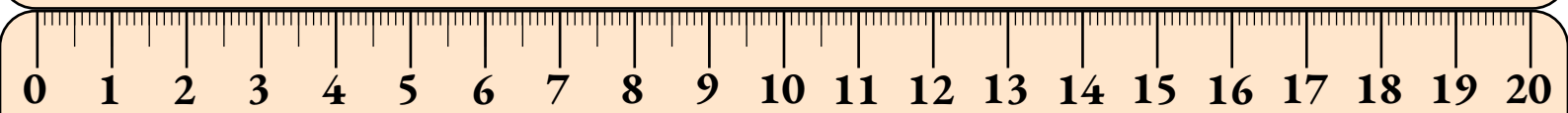

DOUBLE DÉCIMÈTRES π

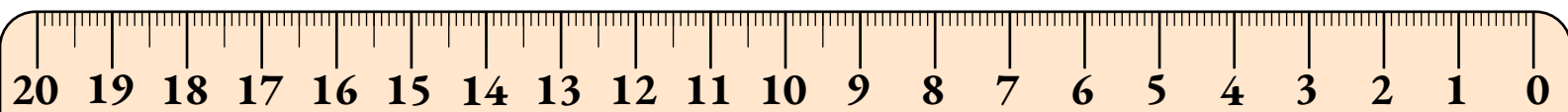

DOUBLE DÉCIMÈTRES π

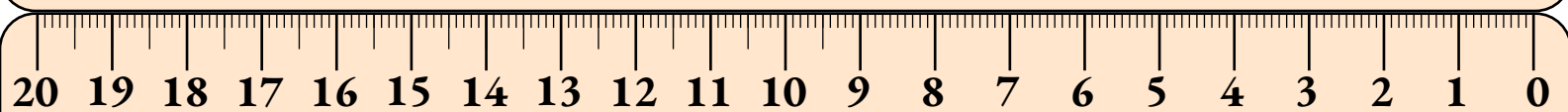

DOUBLE DÉCIMÈTRES π

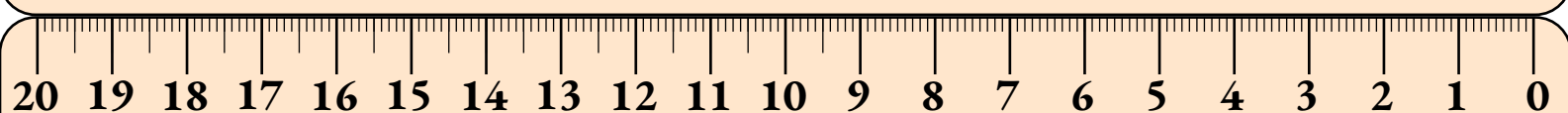

DOUBLE DÉCIMÈTRES π

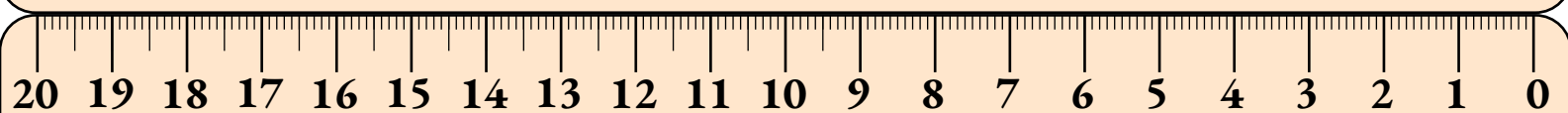

DOUBLE DÉCIMÈTRES π

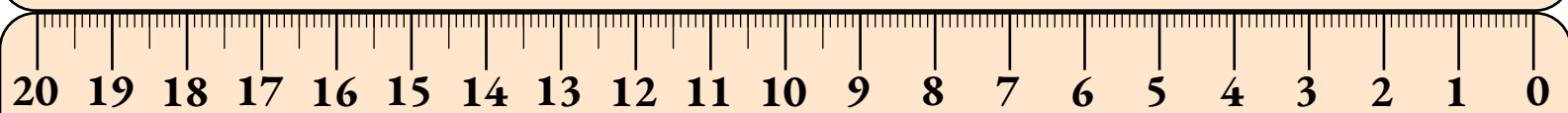

DOUBLE DÉCIMÈTRES π

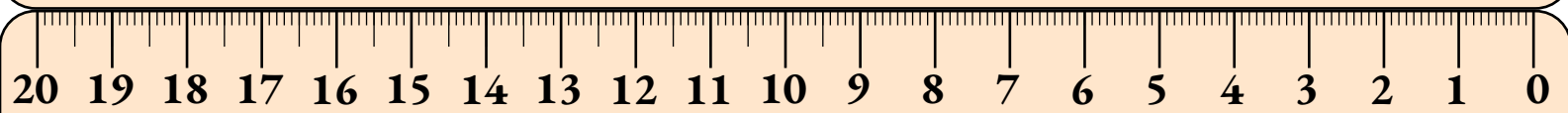

DOUBLE DÉCIMÈTRES π



DOUBLE DÉCIMÈTRES SYMÉTRIE π



DOUBLE DÉCIMÈTRES SYMÉTRIE π

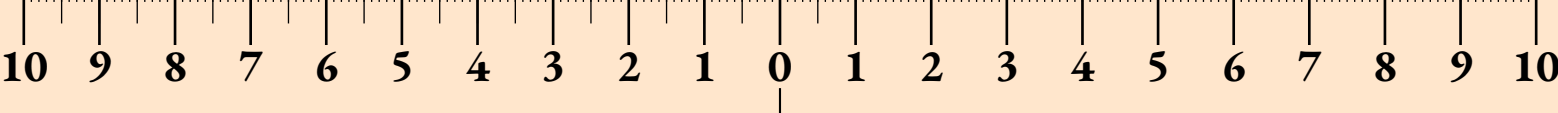

DOUBLE DÉCIMÈTRES SYMÉTRIE π

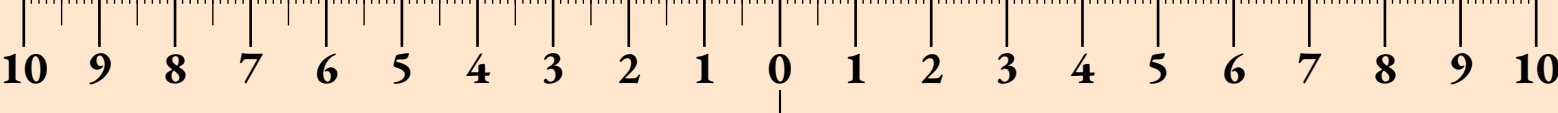

DOUBLE DÉCIMÈTRES SYMÉTRIE π

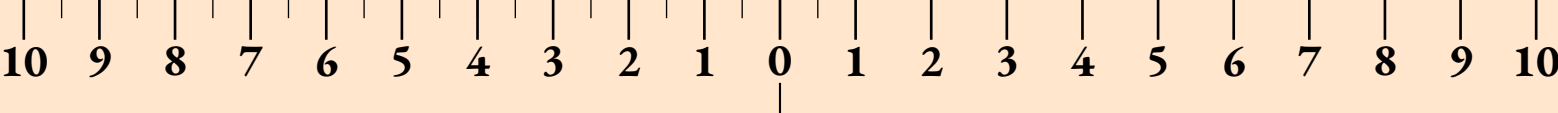

DOUBLE DÉCIMÈTRES SYMÉTRIE π

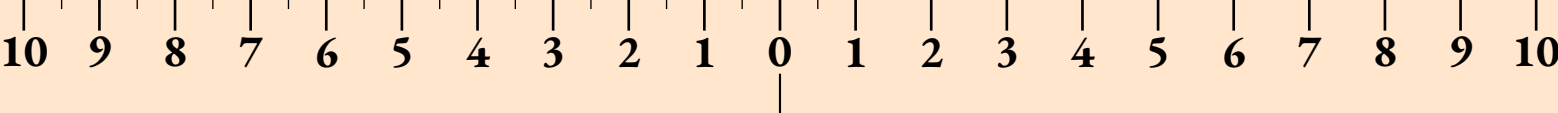

DOUBLE DÉCIMÈTRES SYMÉTRIE π

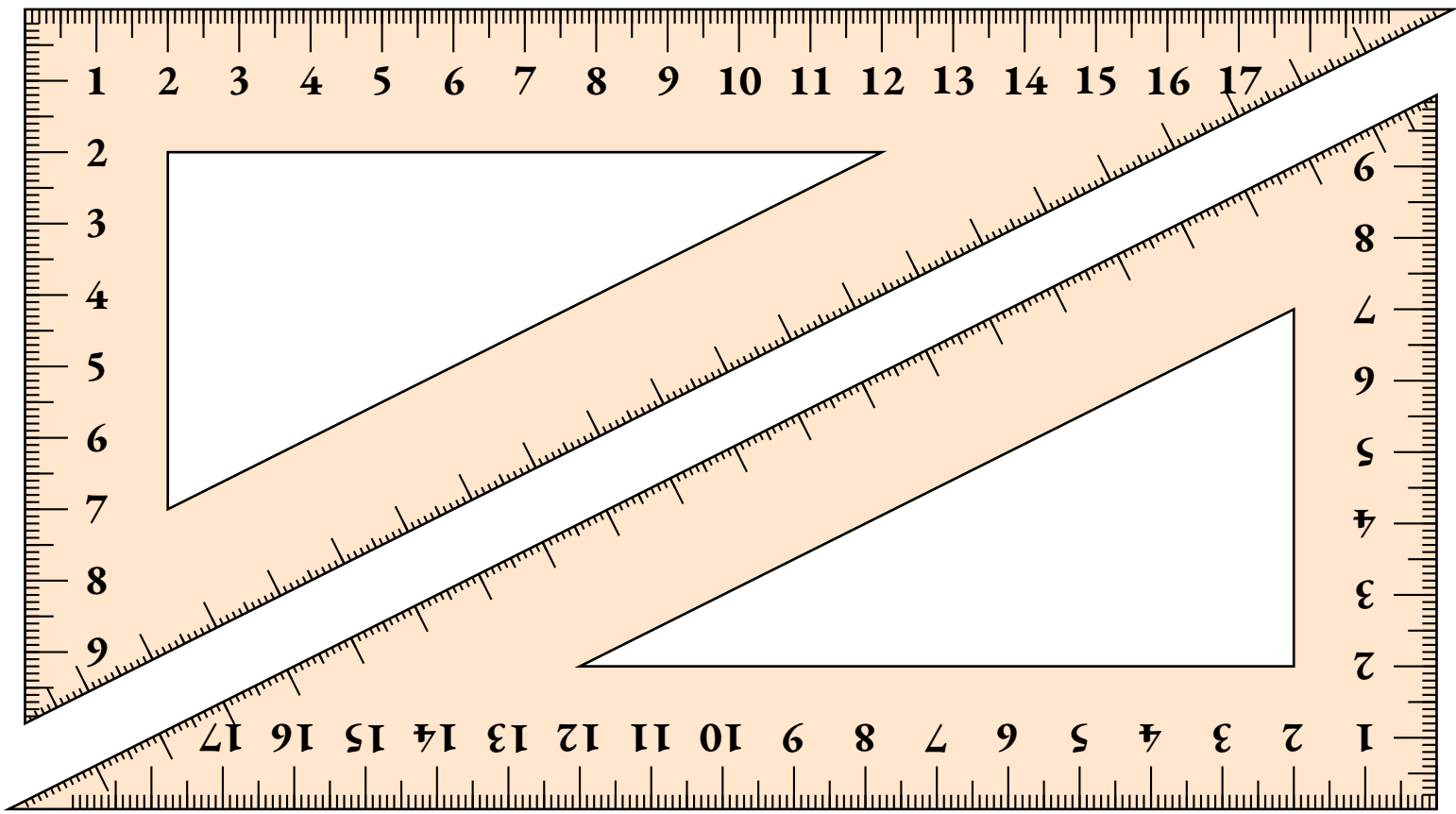
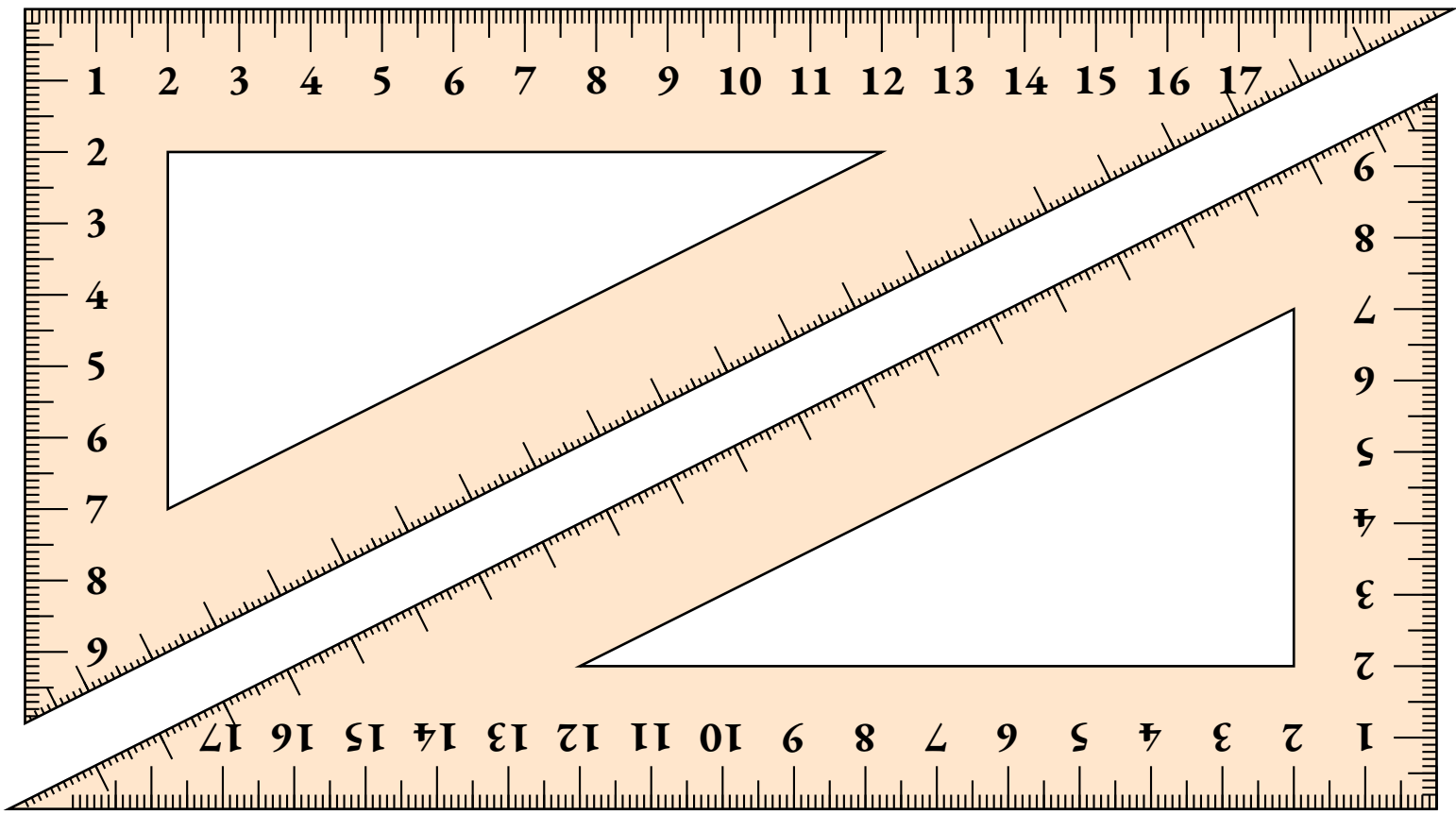

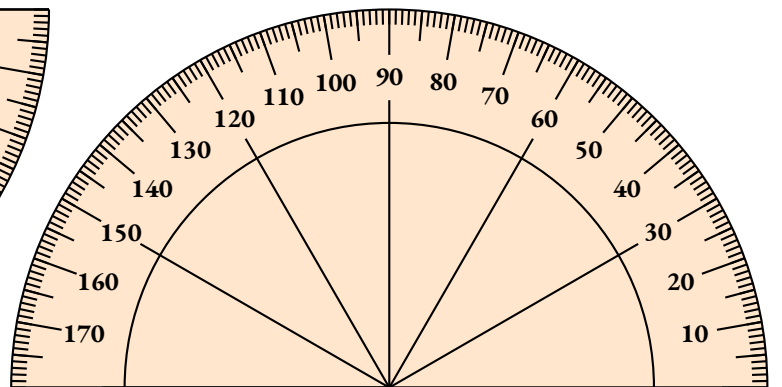
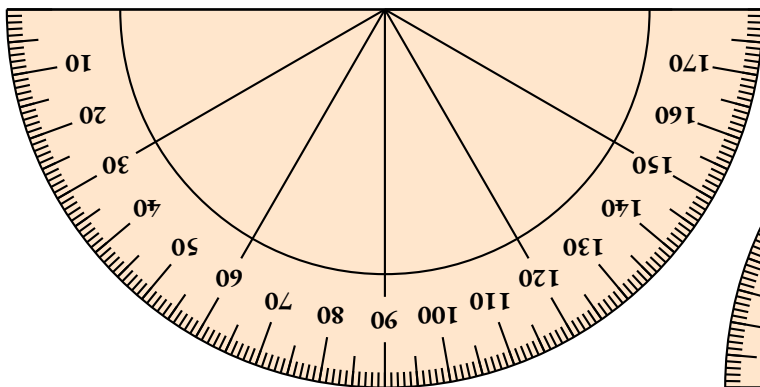
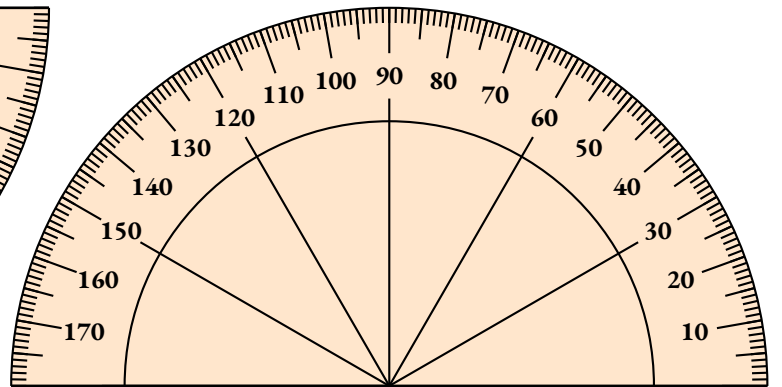
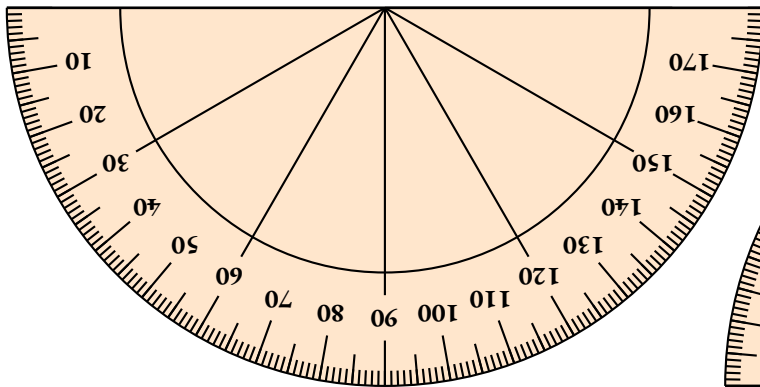
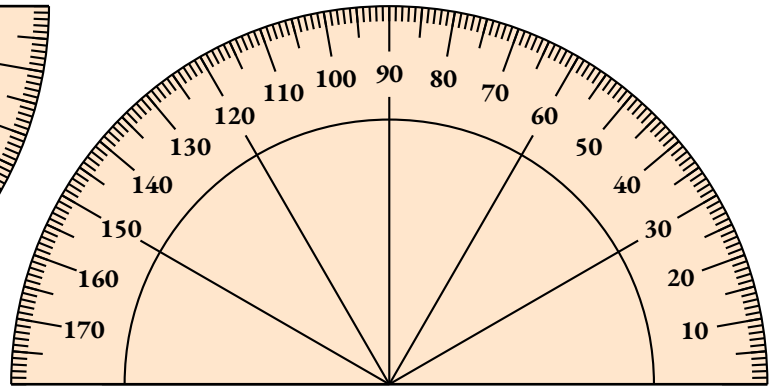
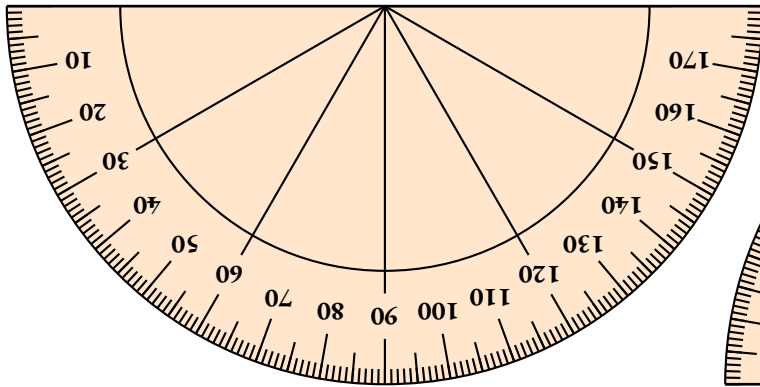
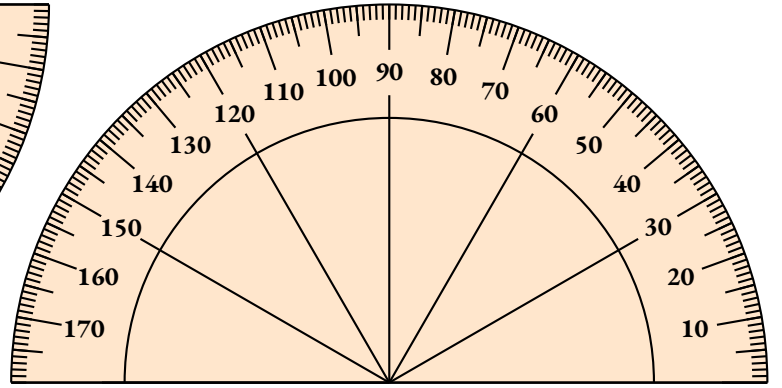
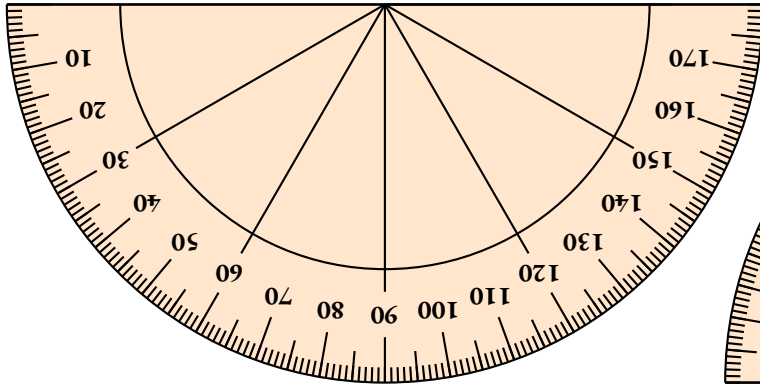
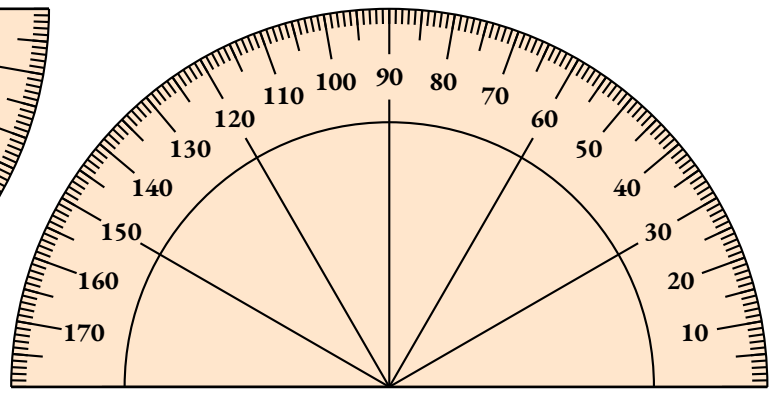
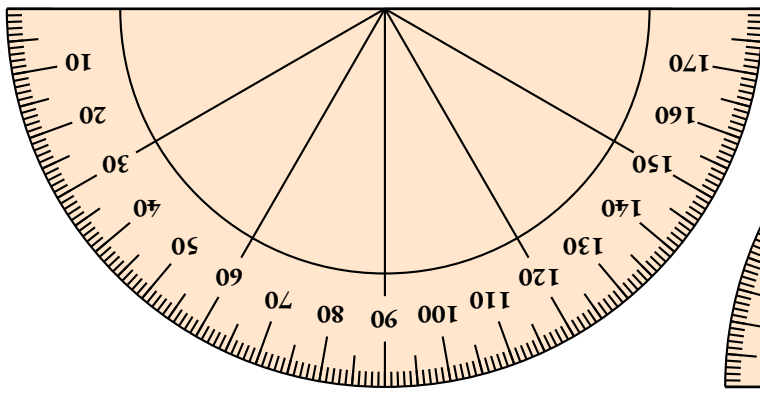

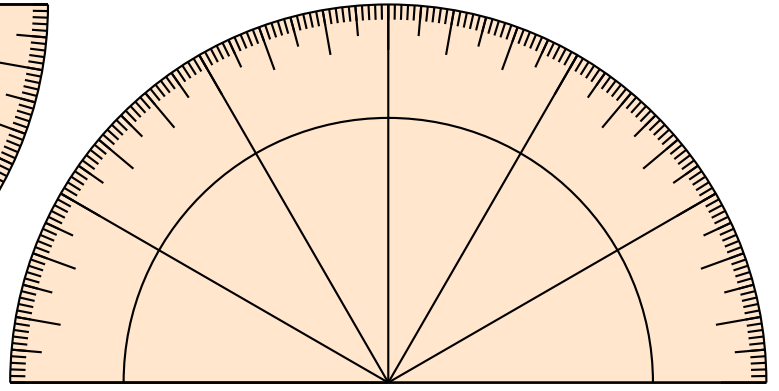
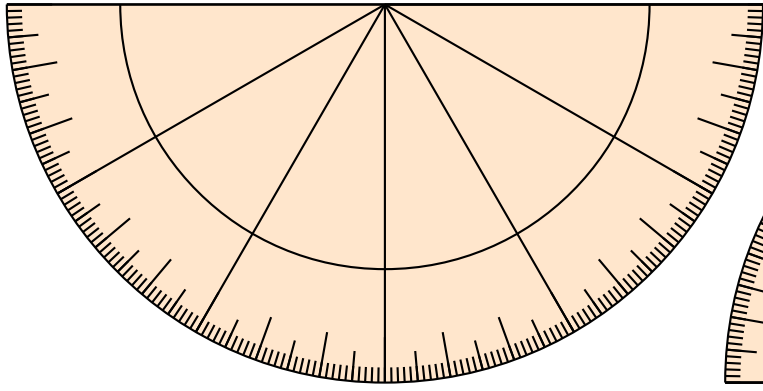
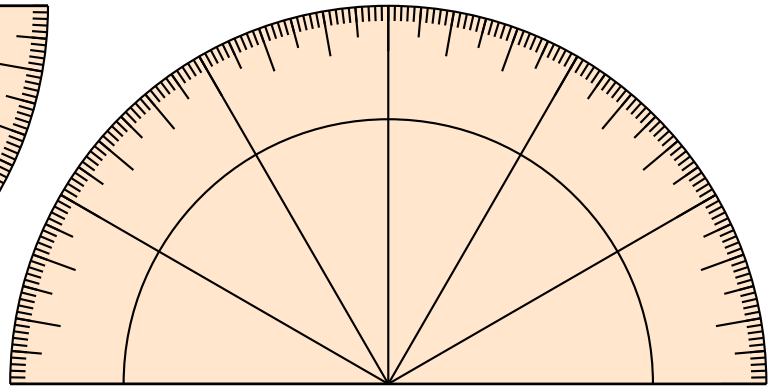
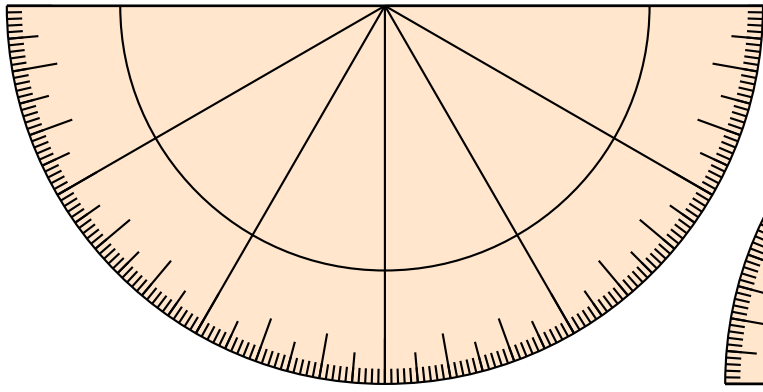
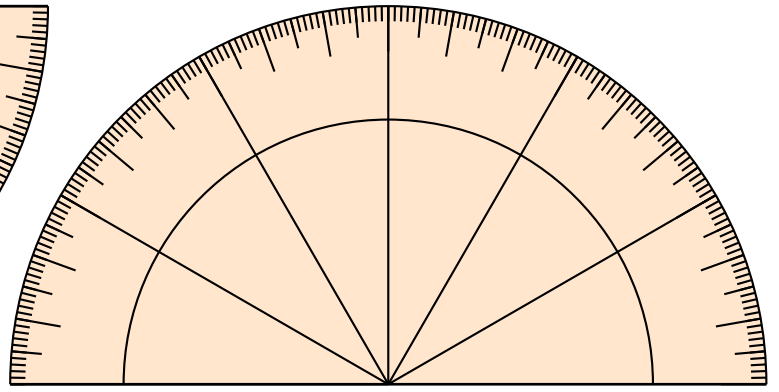
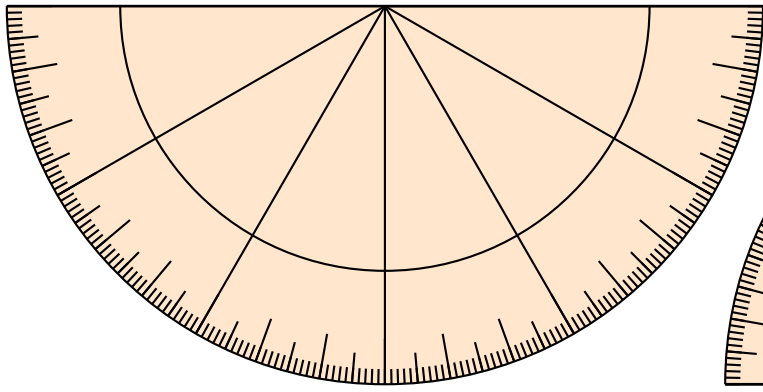
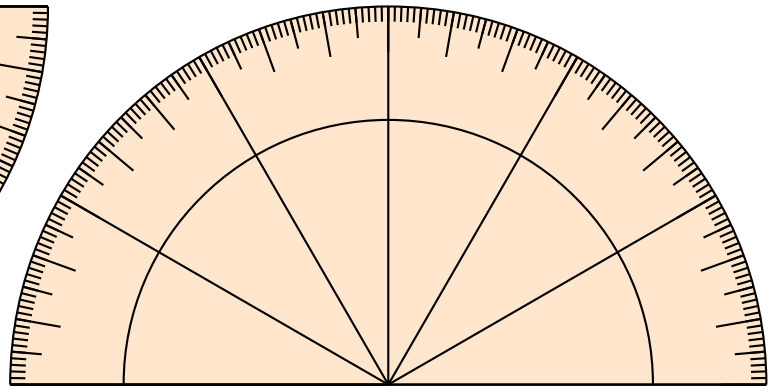
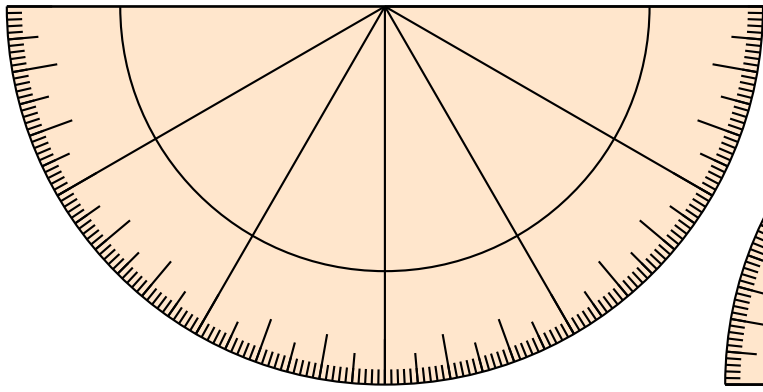
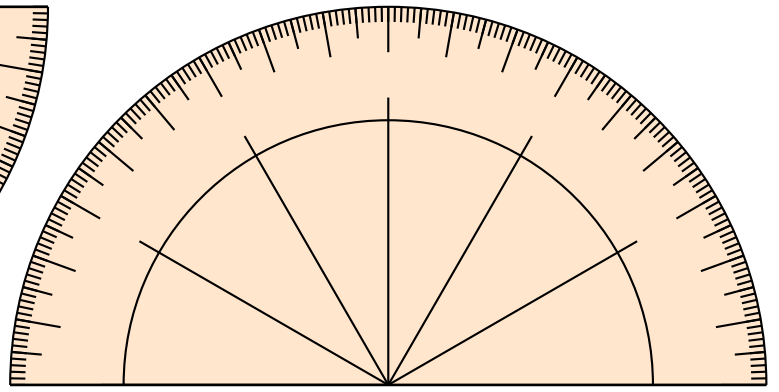
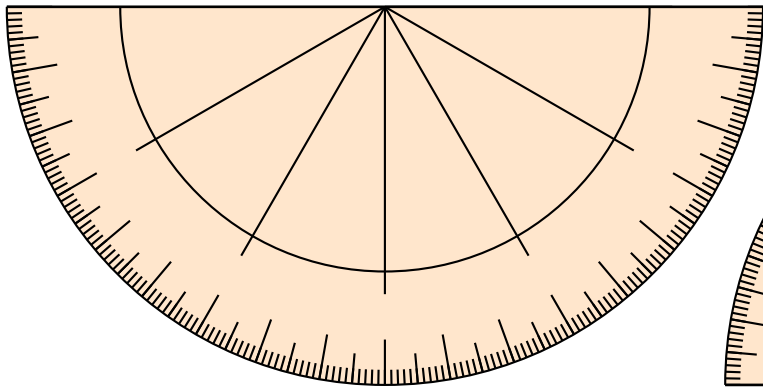



INFORMATIONS LÉGALES

- **Auteur** : Fabrice ARNAUD
- **Web** : pi.ac3j.fr
- **Mail** : contact@ac3j.fr
- **Dernière modification** : 30 avril 2026 à 12:58

Ce document a été écrit pour \LaTeX avec l'éditeur VIM - Vi Improved Vim 9.1.967
Il a été compilé sous Linux Ubuntu Quetting Quokka (Le Quokka en quête) 25.10 avec la distribution TeX Live 2024.20250309 et LuaTeX 1.18.0

Le fichier source a été réalisé sous Linux Ubuntu avec l'éditeur Vim.

J'aimerais beaucoup rendre disponibles mes sources en \TeX . Dans un monde idéal, je le ferai immédiatement. J'ai plusieurs fois constaté que des pilliers du Net me volent mes fichiers pdf, retirent cette dernière page de licence, pour les mettre en ligne et parfois même les rendre payants. N'ayant pas les moyens de mettre un cabinet d'avocats sur cette contravention à la licence CC BY-NC-SA 4.0, je fais le choix de ne pas rendre mes sources disponibles. La plupart des pdf proposés sur ce blog ne contiennent aucun filigrane, je ne les signe pas. Cela permet aux collègues, aux parents, aux élèves, de disposer d'un document anonyme dont chacun peut disposer en respectant la licence qui est particulièrement souple pour les utilisateurs non commerciaux. Je me suis contenté d'ajouter mes références sur cette dernière page. Seules les corrections d'examens contiennent un filigrane vertical. J'ai en effet constaté que certains sites peu scrupuleux, vendaient mes corrections alors qu'elles sont disponibles librement et gratuitement sur mon site. Cette solution est insatisfaisante, je n'ai pas trouvé mieux!

Les QR codes présents sur certains documents pointent vers le fichier pdf lui-même et sa correction. Ce lien ne pointe ni vers une page de mon blog ni vers une quelconque publicité. Vous pouvez le laisser si vous souhaitez que vos élèves accèdent au document en ligne avec sa correction.

Si vous êtes un enseignant et que vous diffusez ce document dans le cadre strict de votre établissement scolaire, inutile de vous poser des questions sur la licence ci-dessous! Dans la mesure où vous limitez cette diffusion à votre classe ou un environnement numérique de travail privé, n'hésitez pas à vous servir!

LICENCE CC BY-NC-SA 4.0



Attribution Pas d'Utilisation Commerciale Partage dans les Mêmes Conditions 4.0 International

Ce document est placé sous licence CC-BY-NC-SA 4.0 qui impose certaines conditions de ré-utilisation.

Vous êtes autorisé à :

Partager — copier, distribuer et communiquer le matériel par tous moyens et sous tous formats

Adapter — remixer, transformer et créer à partir du matériel

L'Offrant ne peut retirer les autorisations concédées par la licence tant que vous appliquez les termes de cette licence.

Selon les conditions suivantes :

Attribution — Vous devez créditer l'Œuvre, intégrer un lien vers la licence et indiquer si des modifications ont été effectuées à l'Œuvre. Vous devez indiquer ces informations par tous les moyens raisonnables, sans toutefois suggérer que l'Offrant vous soutient ou soutient la façon dont vous avez utilisé son œuvre.

Pas d'Utilisation Commerciale — Vous n'êtes pas autorisé à faire un usage commercial de cette Œuvre, tout ou partie du matériel la composant.

Partage dans les Mêmes Conditions — Dans le cas où vous effectuez un remix, que vous transformez, ou créez à partir du matériel composant l'Œuvre originale, vous devez diffuser l'œuvre modifiée dans les mêmes conditions, c'est à dire avec la même licence avec laquelle l'œuvre originale a été diffusée.

Pas de restrictions complémentaires — Vous n'êtes pas autorisé à appliquer des conditions légales ou des mesures techniques qui restreindraient légalement autrui à utiliser l'Œuvre dans les conditions décrites par la licence.

Consulter : <https://creativecommons.org/licenses/by-nc-sa/4.0/deed.fr>

Comment créditer cette œuvre ?

Ce document, **Cours.pdf**, a été créé par **Fabrice ARNAUD (contact@ac3j.fr)** le 30 avril 2026 à 12:58.

Il est disponible en ligne sur **pi.ac3j.fr**, **Le blog de Fabrice ARNAUD**.

Adresse de l'article : <https://pi.ac3j.fr/mathematiques-college>